



H1335

H1336

H1337



T1337

T1335

T1336



H1338



H1339



H1350



H1351



H1352CH



H1352BR



H1353CH



H1353BK



H1352BK



H1355CH



H1355BK



H1355WH



H1356



H1357

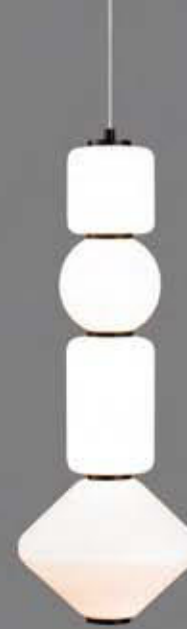

H1358



H1359



H1227



H1228



H1229



H1360GD



H1360GR



H1361CH



H1361PK



H1362BK



H1362BL



H1363-3



H1365



H1369



H1370



H1371



H1366



H1367



H1368



H1372-3



H1373-3



H1375



H1376



H1377



T1377



T1375



H1378



H1379



H1380



H1381



H1382



H1383



H1385



H1386



H1387



H1388L



H1388S



H1389



F1388



T1388





H1390



H1391



H1390



H1392



H1393



H1395



H1396



H1397



H1398



H1399



H1500BR



H1502BR



H1502WH



H1500CH



H1501CP



H1501CH



H1503



T1503



H1332



H1064-4



H1063-1T



H1063-2T



H1063-2F



H1506S

H1506M

H1506L



H1505-6



H1505-2



T1505B



T1505A



H1250



H1333BK

H1333SN



H1507



H1004

H1002

H1003



H1508



H1509



H1510



Page.30



H1511BK-8



H1511BR-8



H1511BK-2



W1511BK-2



H1511BR-2



W1511BR-2



H1512BR



H1512GD



H1513BR



H1515BR



H1516BR



H1517BR



H1518BR



H1519BR



H1520BR





H1517BK



H1518BK



H1521BK



H1519BK



H1522BK



H1520BK



H1516BK



MW9042

MW9044

MW9045

MW9043



H1525

H1523

H1526





H1535WH



H1537WH



H1536WH



H1531



H1532



H1533



H1535BK



H1537BK



H1536BK



H1538

H1539



H1550



H1551BK

H1551CP



H1551GY







H1557BL



H1558PK

H1559GY

H1559BL

H1560GR



H1561-3



H1561-1



H1562





H1200-4



H1200-1



T1200

F1200



H1563CP



Page.53 F1563BR



T1563BR



T1563CP



H1565





H1566



H1567-1

H1567-3

H1567-2



MW6024



MW6025



MW6027



MW6026



MW5015-4



MW5015-3



MW5016



MW5017





H1568



H1569



H1570



F1570





H1571



H1573

H1572

F1573

T1572



H1575



H1203WH

H1203BL

H1203BK

H1203YL



H1029AB

H1029BK

H1023AB

H1028AB



MW9061-2

MW9061-3

MW9061-4

MW9063-2

MW9063-3

MW9063-4





H1576



H1577



H1578

H1579



H1580

H1581

H1582



H1583

H1585

H1586

H1587



T1583



H1588GD-3



H1588BK

H1588CH



H1590GD



H1589GD



H1589CH





H1131GD



H1131BK



H1220



H1218



H1219



H1210



H1221



T1131GD



H1072BK

H1072WH

H1592BK

H1591GD

H1071RD

H1592GD



H1072GD





H1593



H1595



H1596S



H1596L



H1597-2



H1597-1



T1597



F1597



H1598-4



F1598



T1598



H1006



H1007

T1007CP

T1007AB



H1599



H1601



H1600



H1126



H1603GD



H1603BK



H1602BK



H1602CP



H1605BK



H1607

H1606

H1608

H1609

T1607A

T1607B



H1113

H1112

H1111

H1110



H1052NA

H1053NA

H1054NA

H1052BN

H1053BN

H1054BN



H1055BN



F1052BN

F1053BN

F1054BN

T1052NA

T1053NA

T1054NA



H1610NA-S

H1610BK-M

H1610BW-L



H1133-60BK

H1133-80WH

H1134

H1612





H1613



H1615



H1616



H1672NA



H1617WH



H1617BW



H1617NA



T1672A-1



T1672A-2



T1672A-3



T1672B-1



T1672B-2



T1672B-3



F1672NA



F1672BW



T1617BK



T1617NA



F1617NA



F1617BK



H1618BK



H1618CL



H1620



H1621



H1619



H1622



F1622



T1622



H1623PK



H1623WH



H1625



W1623



T1623



H1623WH



H1626PK



T1626PK



H1626WH



T1626WH



H1627



H1628

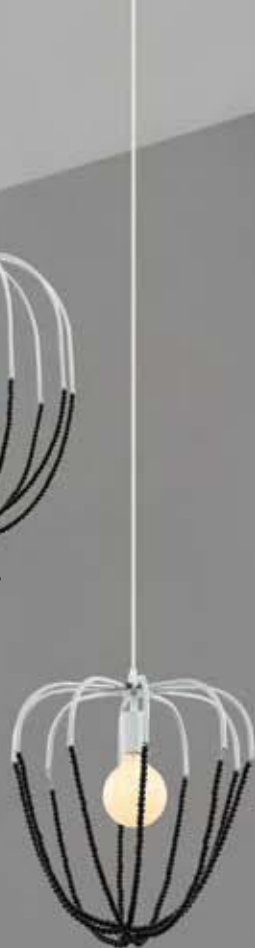

H1629

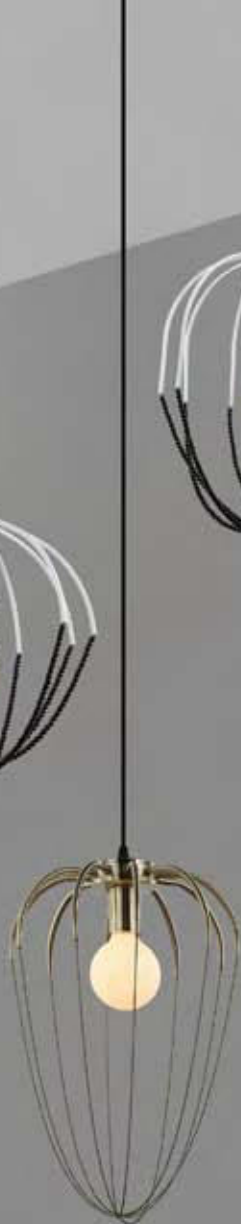

H1630



H1631S



H1631L





H1632WH



H1633A



H1635BK



T1635BK-A

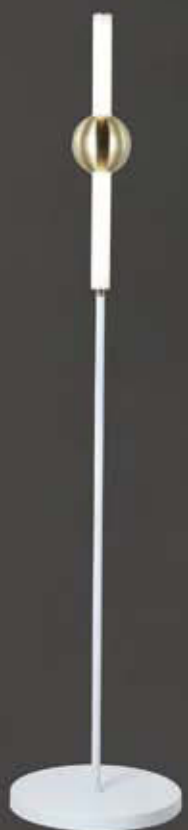

F1632WH



F1632BK



H1633B



F1635WH



F1635BK



T1635WH



T1635BK



H1636BK



H1637BK



F1636WH



T1636WH



H1638-3



H1638-5



H1639-4



H1639-2



H1651-3



H1651-4



H1650-4

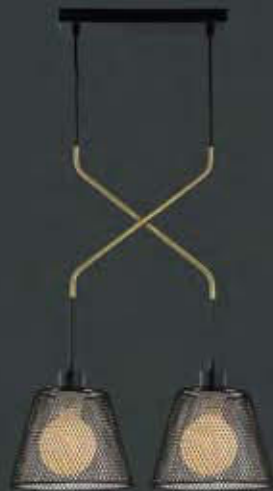

H1650-2



H1652-3



H1652-1



H1653-5



H1653-8



W1653



F1653



T1653



H1655-3



H1655-5



F1655



W1655



T1655



H1655-1



H1656-2



H1657-2



H1656-1



F1656



H1657-1



F1657



T1656



T1657



H1658



H1659

H1661

H1662

H1660

H1663



H1665-3



H1666GD

H1666CH

H1667GD

H1667CP

H1666BK



H1668



H1669RD

H1669GY

H1669WH

H1670GY

H1670RD

H1670WH

H1671WH

H1671GY



T1370GY



T1370WH



T1371RD

T1371WH



T1372GY

T1372RD

T1372WH



T1373WH



T1373RD



T1373GY



T1375GY



T1375WH



T1375RD



T1376WH



T1376RD



T1376GY



F1371GY-A



F1371BK-B



F1377



T1377



T1378RD



T1378GY



T1379WH



T1379GY



T1380WH



T1380GY



T1381GY



T1381WH



T1382GY



T1382WH



T1382RD



T1383



T1385BK



T1385GD



T1386CH



T1386WH



T1351WH



T1351BK



T1392GY



T1392WH



T1387



T1388



T1393GY



T1393WH



T1396



T1395S



T1395L



T1389



T1390



T1391



F1397



T1397



MW-9088-T



MW-9088-F



MW-9086-T

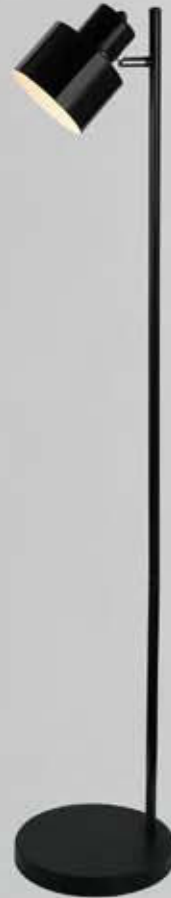

MW-9086-F



F1398



F1500

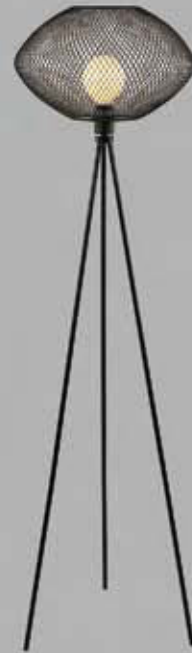

F1399A



F1399B

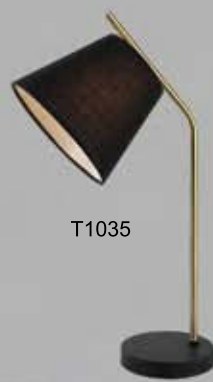

T1035



F1035

Lighting scene display



952F

single light / Three light / dimmable + remote control + APP
880*620*50mm/120W; 650*430*50/48W
Black/white Frame



952F

single light / Three light / dimmable + remote control + APP
600*600/60W; 500*500/45W; 400*400/36W; 300*300mm/24W
Black/white Frame(H=50mm)

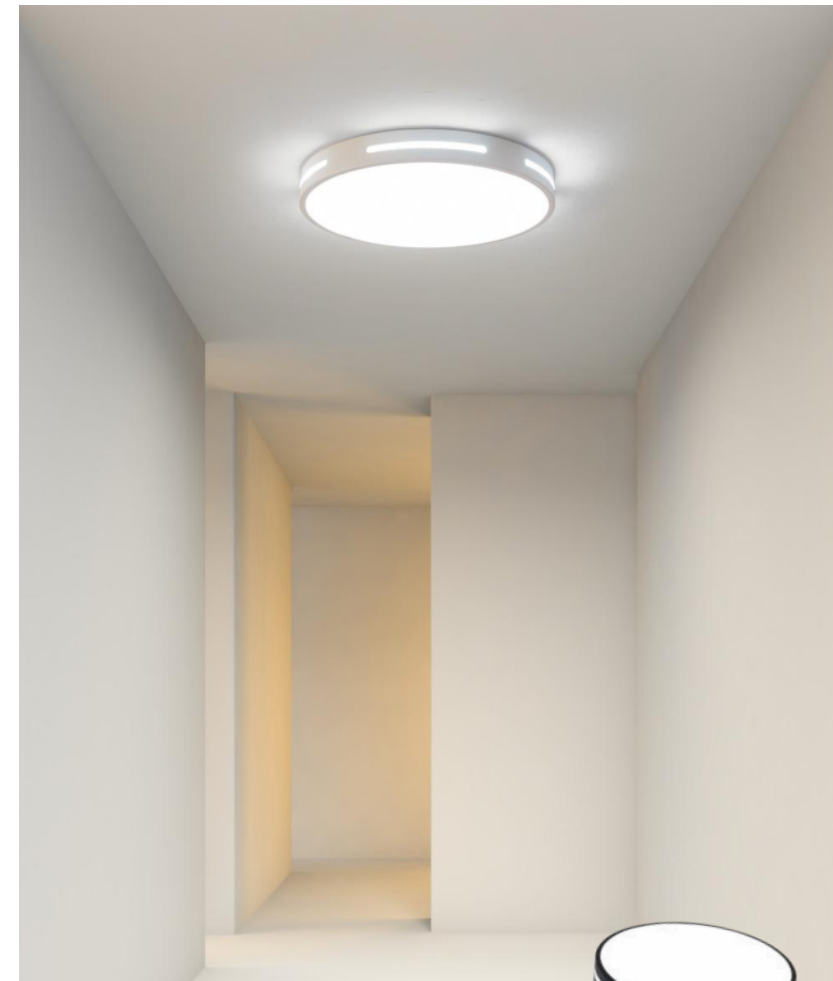

951Y

single light / Three light / dimmable + remote control + APP
Φ600/60W; Φ500/39W; Φ400/30W; Φ300/24W; Φ220/12W
Black/white Frame(H=50mm)

Lighting scene display



963F

single light / Three light / dimmable + remote control + APP
900*600*50mm/120W; 600*400*50/48W
Black/white/gray/pink/Yellow/green/Blue/gold Frame



963F

single light / Three light / dimmable + remote control + APP
500*500*50/45W; 400*400*50/36W; 300*300*50mm/24W
Black/white/gray/pink/Yellow/green/Blue/gold Frame



962Y

single light / Three light / dimmable + remote control + APP
Φ600/60W; Φ500/39W; Φ400/30W; Φ300/24W; Φ220/12W
Black/white/gray/pink/Yellow/green/Blue/gold Frame(H=50mm)

Lighting scene display



871
single light / Three light / dimmable + remote control + APP
950*620*90mm/96W
Black/white Frame



871
single light / Three light / dimmable + remote control + APP
600*600*90mm/48W; 450*450*90mm/27W
Black/white Frame



901
single light / Three light / dimmable + remote control + APP
Φ500*H90mm/36W; Φ400*H90mm/24W
Black/white/gold Frame

Lighting scene display



991
single light / Three light / dimmable + remote control + APP
1150*750*95mm/120W; 900*600*95mm/96W
White Frame



991
single light / Three light / dimmable + remote control + APP
600*600*95mm/60W; 500*500*95/42W
White Frame



919
single light / Three light / dimmable + remote control + APP
Φ500*H100mm/36W; Φ400*H100mm/24W
White/black/gray/pink/Yellow/green Frame

Lighting scene display



992
single light / Three light / dimmable + remote control + APP
950*620*95mm/84W
White Frame



992
single light / Three light / dimmable + remote control + APP
550*550*95mm/48W; 450*450*95/36W
White Frame



931
single light / Three light / dimmable + remote control + APP
Φ480*H90mm/36W
White/black Frame



Lighting scene display



542
single light / Three light / dimmable + remote control + APP
1110*700mm/120W ; 930*650mm/96W ; 650*430mm/48W
Silvery Frame (H=100mm)



542
single light / Three light / dimmable + remote control + APP
650*650*H100mm/60W; 520*520*H100mm/45W;
450*450*H100mm/27W; 300*300*H100mm/18W
Silvery Frame



2320
single light / Three light / dimmable + remote control + APP
Φ400*H100mm/24W; Φ350*H100mm/18W;
Φ300*H100mm/12W
Silvery Frame

Lighting scene display



860F

single light / Three light / dimmable + remote control + APP

900*630*100mm/96W

White Frame



860F

single light / Three light / dimmable + remote control + APP

500*500*100mm/36W

White Frame



860Y

single light / Three light / dimmable + remote control + APP

Φ800mm/72W; Φ500mm/36W; Φ400mm/24W

White Frame (H=100mm)

Lighting scene display



819
single light / Three light / dimmable + remote control + APP
Φ780mm/72W; Φ600mm/48W; Φ500mm/36W; Φ400mm/24W
White Frame (H=90mm)



818
single light / Three light / dimmable + remote control + APP
Φ780mm/72W; Φ520mm/36W; Φ420mm/24W
White Frame (H=100mm)



1104
single light / Three light / dimmable + remote control + APP
Φ500*H100mm/36W; Φ400*H100mm/24W
White/black/ gold Frame

Lighting scene display



912-L

single light / Three light / dimmable + remote control + APP
900*200*50mm/42W; 600*200*50/30W
Black/white/gold Frame



965

single light / Three light / dimmable + remote control + APP
Φ500*H60/39W; Φ400*H60/30W; Φ300*H60/24W
Black/white/pink/green/Blue Frame



1025

single light / dimmable + remote control + APP
Φ500/48W; Φ400/38W; Φ300/28W; Φ220/24W
Black/white (H=20mm) Frame

Lighting scene display



912F

single light / Three light / dimmable + remote control + APP
900*600*50mm/120W; 600*400*50/48W
Black/white/gray/pink/Yellow/green/Blue/gold Frame



912F

single light / Three light / dimmable + remote control + APP
500*500*50/45W; 400*400*50/36W; 300*300*50mm/24W
Black/white/gray/pink/Yellow/green/Blue/gold Frame



911Y

single light / Three light / dimmable + remote control + APP
Φ600/60W; Φ500/39W; Φ400/30W; Φ300/24W; Φ220/12W
Black/white/gray/pink/Yellow/green/Blue/gold Case (H=50mm)

Lighting scene display



869
single light / Three light / dimmable + remote control + APP
950*650*60mm/120W
Black Frame



869
single light / Three light / dimmable + remote control + APP
520*520*60mm/45W; 420*420*60mm/36W
Black Frame



925
single light / Three light / dimmable + remote control + APP
Φ470*H60mm/39
Black+white Frame

Lighting scene display



004
single light / Three light / dimmable + remote control + APP
900*630*100mm/96W
Black Frame



004
single light / Three light / dimmable + remote control + APP
530*530*100mm/36W
Black Frame



914
single light / Three light / dimmable + remote control + APP
Φ300*H60mm/24W; Φ400*H60mm/30W; Φ500*H60mm/39W
Black/white/pink/Yellow/green Frame

Lighting scene display



868-4

single light / Three light / dimmable + remote control + APP
500*500*85mm/48W
White+black/ White Frame



869-4

single light / Three light / dimmable + remote control + APP
500*500*85mm/48W
White+black/ White Frame



968

single light / Three light / dimmable + remote control + APP
Φ500*H80mm/42W
White+black Frame

Lighting scene display



986F

single light / Three light / dimmable + remote control + APP
960*630*80mm/96W
White+black Frame



986F

single light / Three light / dimmable + remote control + APP
500*500*80mm/36W
White+black Frame



985Y

single light / Three light / dimmable + remote control + APP
Φ500*H80mm/30W ; Φ400*H80mm/24W
White+black Frame

Lighting scene display



953
single light / Three light / dimmable + remote control + APP
480*480*85mm/42W; 380*380*85mm/30W
Black+white Frame



926
single light / Three light / dimmable + remote control + APP
520*455*85mm/36W; 420*400*85mm/36W
Black+white Frame



927
single light / Three light / dimmable + remote control + APP
480*480mm/36W; 480*480mm/28W; 280*280mm/18W
Black+white Frame (H=85mm)

Lighting scene display



980
single light / Three light / dimmable + remote control + APP
1150*750*100mm/120W; 900*600*100mm/99W
Black+white Frame



980
single light / Three light / dimmable + remote control + APP
500*500*100mm/48W
Black+white Frame



927
single light / Three light / dimmable + remote control + APP
520*480*90mm/36W; 420*380*90mm/30W
Black+white Frame

Lighting scene display



981
single light / Three light / dimmable + remote control + APP
1150*750*120mm/120W; 950*620*120mm/84W
Black+white Frame



981
single light / Three light / dimmable + remote control + APP
500*500*120mm/48W
Black+white Frame



922
single light / Three light / dimmable + remote control + APP
520*490*80mm/36W
Black+white Frame

Lighting scene display



815-6
single light / Three light / dimmable + remote control + APP
960*620*120mm/96W
Black+white Frame



815-4
single light / Three light / dimmable + remote control + APP
620*620*120mm/72W
Black+white Frame



870
single light / Three light / dimmable + remote control + APP
Φ520*H80mm/36W ; Φ620*H80mm/48W
Black+white Frame

Lighting scene display

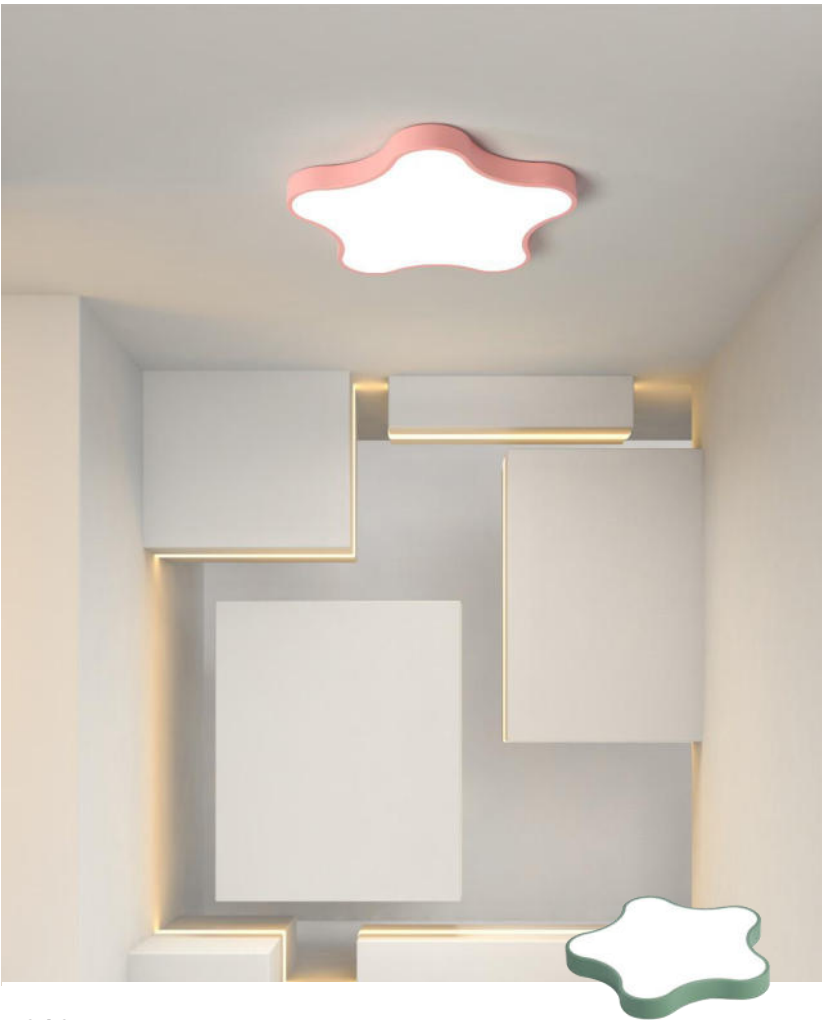

916
single light / Three light / dimmable + remote control + APP
Φ500*H50mm/39W; Φ400*H50mm/30W
Pink/white/black/yellow/green Frame



917
single light / Three light / dimmable + remote control + APP
Φ300*H50mm/24W; Φ400*H50/30W; Φ500*H50/39W
Yellow/pink/white/black/green Frame



918
single light / Three light / dimmable + remote control + APP
580*365*50mm/42W; 480*300*50mm/36W
Green /pink/white/black/yellow Frame

Lighting scene display



1009

single light / Three light / dimmable + remote control + APP
480*300*50mm/36W; 580*365*50mm/42W
White/blue/pink Frame



1022

single light / Three light / dimmable + remote control + APP
420*395*50mm/39W
Blue Frame



920

single light / Three light / dimmable + remote control + APP
Φ500*H90mm/36W; Φ400*H90mm/24W
Pink/white/blue Frame

Lighting scene display



1085

Three light / dimmable + remote control + APP

Φ460*H90mm/51W

Blue Frame



1086

Three light / dimmable + remote control + APP

550*400*80mm/58W

Pink Frame



1087

Three light / dimmable + remote control + APP

Φ460*H90mm/51W

Pink Frame

Lighting scene display



1020

single light / Three light / dimmable + remote control + APP
Φ550*H120mm/64W
Silver+white /Black+white Frame



1030

single light / Three light / dimmable + remote control + APP
Φ550*H120mm/66W
Brown+white / Silver+white Frame



1034

single light / Three light / dimmable + remote control + APP
Φ500*H140mm/58W
Brown+white / Blue+white Frame

Lighting scene display



1078

single light / Three light / dimmable + remote control + APP
Φ500*H80mm/65W
Black+white Frame



1079

single light / Three light / dimmable + remote control + APP
Φ500*H80mm/65W
Black+white Frame



1080-500Y

single light / Three light / dimmable + remote control + APP
Φ500*H75mm/58W
Black+white+gold Frame

Lighting scene display



1035

single light / Three light / dimmable + remote control + APP
650*450*H80mm,Hanging wire 100cm /60W
White Frame



1041

single light / Three light / dimmable + remote control + APP
Φ520*H120mm,Hanging wire 100cm/48W
White Frame



1034

single light / Three light / dimmable + remote control + APP
Φ550*H80mm,Hanging wire 100cm/48W
White Frame

Lighting scene display



1066

single light / Three light / dimmable + remote control + APP
Φ500*H50mm/60W
Gold/black Frame



MC201

single light / Three light / dimmable + remote control + APP
Φ460*H120mm/48W
Gold/black/white Frame



1093

single light / Three light / dimmable + remote control + APP
Φ500*H50mm/59W
Gold Frame

Lighting scene display



1058F

single light / Three light / dimmable + remote control + APP
1100*600*50mm/109W; 900*500*50/86W
Gold/black/white Frame



1058F

single light / Three light / dimmable + remote control + APP
600*600/74W; 500*500/61W; 400*400/48W; 300*300mm/35W
Gold/black/white Frame (H=50mm)



1058Y

single light / Three light / dimmable + remote control + APP
Φ600/59W; Φ500/50W; Φ400/39W; Φ300/29W; Φ220/19W
Gold/black/white Frame (H=50mm)

Lighting scene display



1053F

single light / Three light / dimmable + remote control + APP
950*650*60mm/170W
Gold Frame



1053F

single light / Three light / dimmable + remote control + APP
550*550*60mm/78W; 450*450*60/63W
Gold Frame



1053Y

single light / Three light / dimmable + remote control + APP
Φ550*H60mm/66W; Φ450*H60mm/52W
Gold Frame

Lighting scene display



Modern absorb dome light

In pursuit of the design concept of lamps and lanterns of comfort as the core of modern fashion and clever combination of simple and practical lighting function, change your loved by users



MC002

single light / Three light / dimmable + remote control + APP
480*460*140mm/56W
Black/Gold/white Frame



MC060

single light / Three light / dimmable + remote control + APP
Φ520*H120mm/56W
Black /Rose gold/gold /Gold/white Frame



Modern absorb dome light

In pursuit of the design concept of lamps and lanterns of comfort as the core of modern fashion and clever combination of simple and practical lighting function, change your loved by users



MC201

single light / Three light / dimmable + remote control + APP
Φ560*H100mm/72W
Black/Gold/white Frame

Lighting scene display



1051F

single light / Three light / dimmable + remote control + APP
900*600*50mm/168W
Black Frame



1051F

single light / Three light / dimmable + remote control + APP
500*500*50mm/77W; 400*400*50/62W; 300*300*50/43W
Black Frame



1051Y

single light / Three light / dimmable + remote control + APP
Φ500*H50mm/64W; Φ400*H50/51W; Φ300*H50/40W
Black Frame

Lighting scene display



1052F

single light / Three light / dimmable + remote control + APP
1100*700*60mm/169W; 900*600*60/131W
Black/gold Frame



1052F

single light / Three light / dimmable + remote control + APP
500*500*60mm/62W; 400*400*60/55W
Black/gold Frame



1064Y

single light / Three light / dimmable + remote control + APP
Φ420*H60mm/55W
Black/gold Frame

Lighting scene display



1068F

single light / Three light / dimmable + remote control + APP

1120*720*60mm/196W;900*580*60mm/150W

Black+white Frame



1068F

single light / Three light / dimmable + remote control + APP

500*500*60mm/91W

Black+white Frame



1068Y

single light / Three light / dimmable + remote control + APP

Φ500*H60mm/73W

Black+white Frame

Lighting scene display



1017F

single light / Three light / dimmable + remote control + APP

900*600*60mm/138W

Black Frame



1017F

single light / Three light / dimmable + remote control + APP

500*500*60mm/69W

Black Frame



1017Y

single light / Three light / dimmable + remote control + APP

Φ500*H60mm/70W

Black Frame

Lighting scene display



1018F

single light / Three light / dimmable + remote control + APP

900*600*60mm/144W

Black Frame



1018F

single light / Three light / dimmable + remote control + APP

500*500*60mm/66W

Black Frame



1018Y

single light / Three light / dimmable + remote control + APP

Φ500*H60mm/64W

Black Frame

Lighting scene display



1019F

single light / Three light / dimmable + remote control + APP

900*600*60mm/144W

Black Frame



1019F

single light / Three light / dimmable + remote control + APP

500*500*60mm/78W

Black Frame



1019Y

single light / Three light / dimmable + remote control + APP

Φ500*H60mm/61W

Black Frame

Lighting scene display



1114F

single light / Three light / dimmable + remote control + APP
1100*700*55mm/120W
Black+white /Black+white+gold Frame



1114F

single light / Three light / dimmable + remote control + APP
520*520*55mm/58W; 420*420*55/48W
Black+white /Black+white+gold Frame

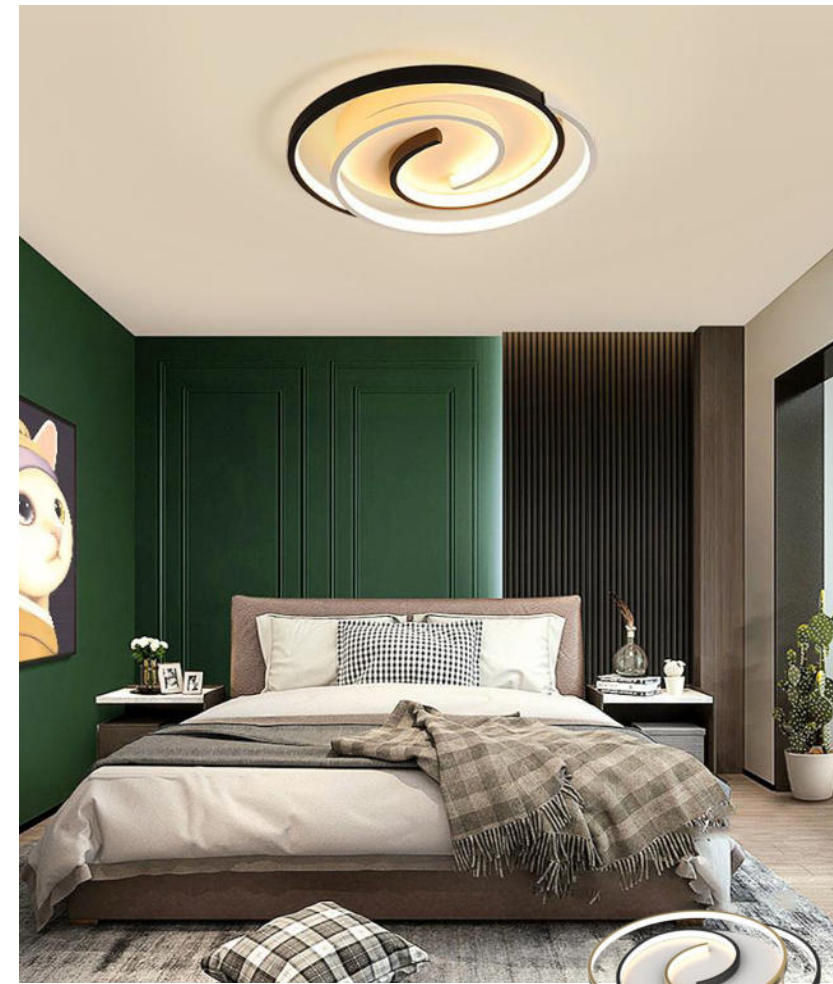

1114Y

single light / Three light / dimmable + remote control + APP
Φ520*H55mm/48W; Φ420*H55mm/40W
Black+white /Black+white+gold Frame

Lighting scene display



1109-480Y
single light / Three light / dimmable + remote control + APP
Φ480*H50mm/30W
White+gold Frame



1109-480F
single light / Three light / dimmable + remote control + APP
480*480*50mm/30W
White+gold Frame



1109-530C
single light / Three light / dimmable + remote control + APP
480*480*H50mm/30W
White+gold Frame

Lighting scene display



1104-480Y
single light / Three light / dimmable + remote control + APP
Φ480*H60mm/47W
Black+gold Frame



1104-480F
single light / Three light / dimmable + remote control + APP
480*480*60mm/63W
Black+gold Frame



1104-480C
single light / Three light / dimmable + remote control + APP
480*480*H60mm/51W
Black+gold Frame

Lighting scene display



1103F

single light / Three light / dimmable + remote control + APP
960*630*70mm/113W
Blue +white+gold /Black+white+gold Frame



1103F

single light / Three light / dimmable + remote control + APP
420*420*60mm/53W
Blue +white+gold /Black+white+gold Frame



1103Y

single light / Three light / dimmable + remote control + APP
Φ420*H60mm/42W
Blue +white+gold /Black+white+gold Frame

Lighting scene display



1102F

single light / Three light / dimmable + remote control + APP
960*640*50mm/126W
Black+gold Frame



1102F

single light / Three light / dimmable + remote control + APP
480*480*50mm/46W
Black+gold Frame



1102Y

single light / Three light / dimmable + remote control + APP
Φ480*H50mm/42W
Black+gold Frame

Lighting scene display



1101F
single light / Three light / dimmable + remote control + APP
960*580*50mm/110W
Black+white+gold Frame



1101F
single light / Three light / dimmable + remote control + APP
530*450*50mm/65W
Black+white+gold Frame



1101Y
single light / Three light / dimmable + remote control + APP
Φ530*H50mm/55W
Black+white+gold Frame



Lighting scene display



1968-L
single light / Three light / dimmable + remote control + APP
Φ600*H30mm,Hanging wire 100cm /60W
Gold/black/white Frame



1968-S
single light / Three light / dimmable + remote control + APP
Φ400+Φ200*H30mm /30W
Gold/ black/white Frame (Hanging wire 100cm)



1053-L
single light / Three light / dimmable + remote control + APP
Φ500*H50mm,Hanging wire 100cm/48W
Gold Frame

Lighting scene display



PZE-922

single light / Three light / dimmable + remote control + APP
400*350*120mm,Hanging wire 100cm/48W;
Gold/ black Frame



PZE-924

single light / Three light / dimmable + remote control + APP
Φ400*H120mm,Hanging wire 100cm/58W
Gold/ black Frame

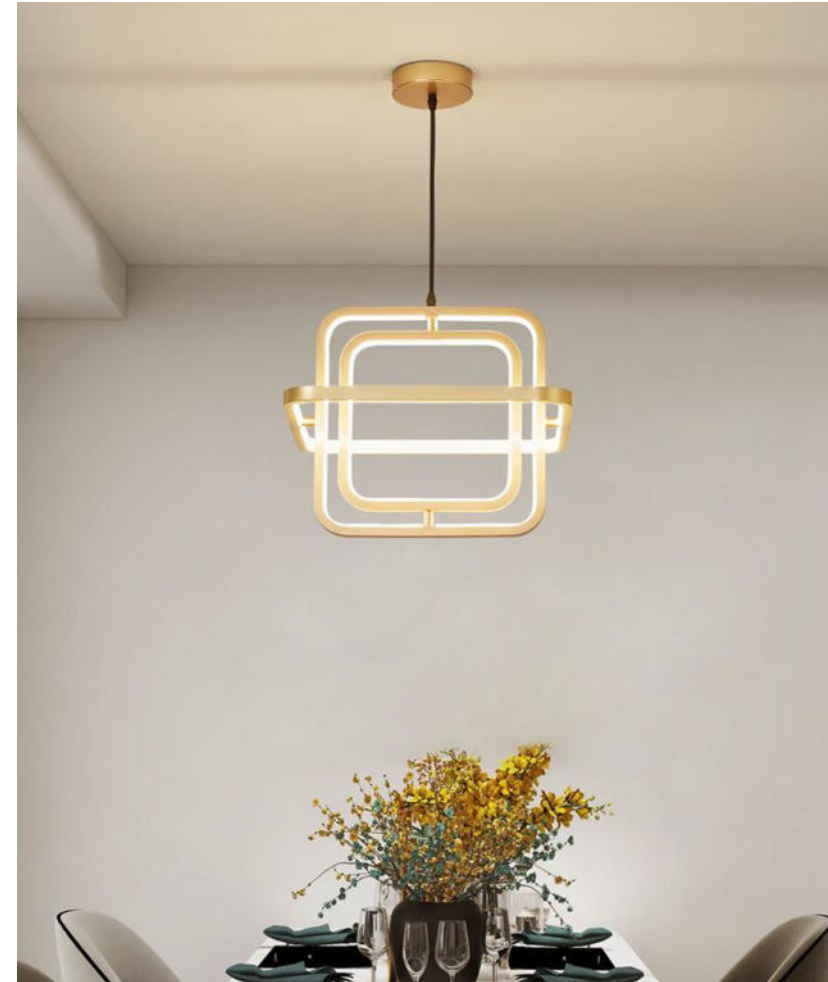

PZE-925

single light / Three light / dimmable + remote control + APP
400*400*120mm,Hanging wire 100cm/68W
Gold/ black Frame

Lighting scene display



1001
Without light source
E27*8/Φ900; E27*6/Φ780; E27*3/Φ500(H=30mm)
White/grey Frame



1018
Without light source
E27*8/Φ850; E27*6/Φ720; E27*3/Φ560(H=30mm)
Black/white Frame



1003
Without light source
E27*16/Φ900; E27*12/Φ900; E27*10/Φ900; E27*8/Φ900;
E27*6/Φ750(H=50mm)
Gold/ black Frame

Lighting scene display



Modern absorb dome light

In pursuit of the design concept of lamps and lanterns of comfort as the core of modern fashion and clever combination of simple and practical lighting function, change your loved by users

209-8

Without light source
E27*8/Φ770*H1300mm)
Black+gold Frame



819

single light / Three light / dimmable + remote control + APP
Φ600*H180mm/60W; Φ460*H180mm/50W;
Rose gold /Gold/ black Frame (Hanging wire 100cm)



Modern lamp light luxury restaurant

In pursuit of the design concept of lamps and lanterns of comfort as the core of modern fashion and clever combination of simple and practical lighting function, change your loved by users

PZE-920

single light / Three light / dimmable + remote control + APP
750*290*50mm,Hanging wire 100cm/73W
Gold/ black Frame



Thank you !





MSW-G001



MSW-G004



MSW-G002



MSW-G003



MSW-G005



MSW-G006



MSW-G007



MSW-G008



MSW-G011



MSW-G014



MSW-G009



MSW-G012



MSW-G015



MSW-G016



MSW-G017



MSW-G013



MSW-G010



MSW-G018



MSW-G019



MSW-G020



MSW-G021



MSW-G022



MSW-G023



MSW-G026



MSW-G030



MSW-G024



MSW-G025



MSW-G028



MSW-G027



MSW-G029

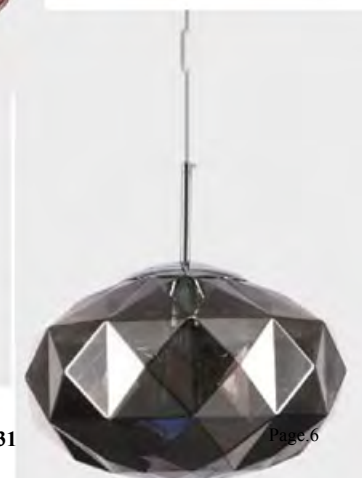

MSW-G031

MSW-G032



MSW-G035



MSW-G033



MSW-G036



MSW-G034



MSW-G037



MSW-G038



MSW-G039





MSW-G040



MSW-G041



MSW-G045



MSW-G042



MSW-G046



MSW-G047



MSW-G043



MSW-G044



MSW-G048



MSW-G051



MSW-G049



MSW-G052



MSW-G050



MSW-C001



MSW-C002



MSW-C003



MSW-C004



MSW-C005



MSW-C006



MSW-C007



MSW-1001



MSW-1005



MSW-1006



MSW-1002



MSW-1004



MSW-1007



MSW-1003



MSW-1008



MSW-I009



MSW-I012



MSW-I010



MSW-I011



MSW-I014



MSW-I013



MSW-I016



MSW-I015



Page.16



MSW-I017



MSW-I018



MSW-I019



MSW-I020



MSW-I021



MSW-I022



MSW-I024



MSW-I023



MSW-I025



MSW-I026



MSW-I027



MSW-I028



MSW-I030

MSW-I029



MSW-I031



MSW-I032



MSW-I033



MSW-I034



MSW-I035



MSW-I036



MSW-I037



MSW-I038



MSW-I039



MSW-1040



MSW-1046



MSW-1047



MSW-1048



MSW-1041



MSW-1042



MSW-1044



MSW-1049



MSW-1051



MSW-1043



MSW-1045



MSW-1050



MSW-1052



MSW-1053



MSW-1057



MSW-1059



MSW-1058



MSW-1054



MSW-1055



MSW-1056



MSW-1060



MSW-1061



MSW-1062



MSW-1063



MSW-1064

MSW-1065

MSW-1066

MSW-1067

MSW-1068

MSW-1069

MSW-1070



MSW-1071

MSW-1072

MSW-1073

MSW-1074

MSW-1075



MSW-1076



MSW-1077



MSW-1078



MSW-1079



MSW-1080



MSW-1081



MSW-1082



MSW-1083



MSW-1084



MSW-1085



MSW-1086





MSW-I087



MSW-I089



MSW-I092



MSW-I094



MSW-I096



MSW-I088



MSW-I090



MSW-I093



MSW-I095



MSW-I091



MSW-L001



MSW-L004



MSW-L002



MSW-L003



MSW-L005



MSW-L006



MSW-L007



MSW-L008



MSW-L012



MSW-L009



MSW-L011



MSW-L010



MSW-L013



MSW-L014



MSW-L015



MSW-L016



MSW-L017



MSW-L021



MSW-L018



MSW-L022



MSW-L019



MSW-L020



MSW-L023



MSW-L024



MSW-L025



MSW-L026



MSW-L028



MSW-L027



MSW-L029



MSW-L030



MSW-L031



MSW-L034



MSW-L032



MSW-L033



MSW-L035



MSW-L036



MSW-L037



MSW-L038



MSW-L039



MSW-L042



MSW-L040



MSW-L041

MSW-L043



MSW-L049

MSW-L044



MSW-L045



MSW-L048



MSW-L050



MSW-L052



MSW-L046



MSW-L047



MSW-L051





MSW-N001

MSW-N002

MSW-N003

MSW-N004

MSW-N006

MSW-N005

MSW-N007

MSW-N009

MSW-N008

MSW-N010

MSW-N012

MSW-N011

MSW-N013



MSW-N014



MSW-N015



MSW-N020



MSW-N021



MSW-N022



MSW-N017



MSW-N016



MSW-N018



MSW-N023



MSW-N019



MSW-N024



MSW-N025



MSW-N028



MSW-N026



MSW-N029



MSW-N030



MSW-N027



MSW-N031



MSW-N034



MSW-N036



MSW-N032



MSW-N033



MSW-N035



MSW-N037



MSW-N039



MSW-N044



MSW-N046



MSW-N038



MSW-N040



MSW-N045



MSW-N041



MSW-N042



MSW-N048



MSW-N047



MSW-N043



MSW-N049



MSW-N050



MSW-N051



MSW-N056



MSW-N057



MSW-N058



MSW-N052



MSW-N053



MSW-N054



MSW-N059



MSW-N060



MSW-N055



MSW-N061



MSW-N062





MSW-N063



MSW-N064



MSW-N068



MSW-N069

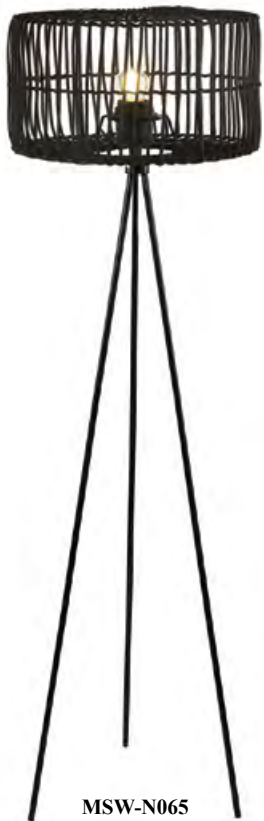

MSW-N065



MSW-N066



MSW-N067



MSW-N070



MSW-N071



MSW-B003



MSW-B001



MSW-B002



MSW-B006



MSW-B004



MSW-B005



MSW-B007



MSW-B008



MSW-B009



MSW-B011



MSW-B010



MSW-B014



MSW-B015



MSW-B016



MSW-B012



MSW-B013



MSW-B017



MSW-B018



MSW-B019



MSW-B022



MSW-B023



MSW-B020



MSW-B021



MSW-B024



MSW-B025



MSW-B026



MSW-B031



MSW-B032



MSW-B027



MSW-B028



MSW-B029



MSW-B030



MSW-B033



MSW-B034



MSW-W001

MSW-W002

MSW-W003



MSW-W004



MSW-W005

MSW-W006

MSW-W007

MSW-W008



MSW-W009

MSW-W010



MSW-W011

MSW-W012



MSW-W013

MSW-W014

MSW-W015

MSW-W016

MSW-W017

MSW-W018



MSW-W019



MSW-W020



MSW-W021



MSW-W022



MSW-W025



MSW-W023



MSW-W027



MSW-W024



MSW-W026



MSW-W028



MSW-W029



MSW-P001



MSW-P002



MSW-P003



MSW-P004



MSW-P006



MSW-P007

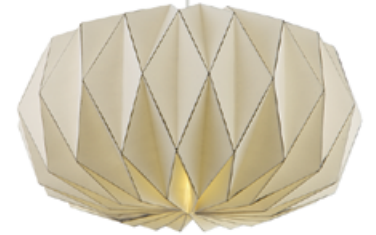

MSW-P008



MSW-P006



MSW-P005



MSW-P009



MSW-S001



MSW-S005



MSW-S009



MSW-S013



MSW-S002



MSW-S006



MSW-S010



MSW-S014



MSW-S003



MSW-S007



MSW-S011



MSW-S015



MSW-S004



MSW-S008



MSW-S012



MSW-S016



MSW-S017



MSW-S021



MSW-S025



MSW-S029



MSW-S018



MSW-S022



MSW-S026



MSW-S030



MSW-S019



MSW-S023



MSW-S027



MSW-S031



MSW-S020



MSW-S024



MSW-S028



MSW-S032



MSW-S033



MSW-S037



MSW-S041



MSW-S045



MSW-S034

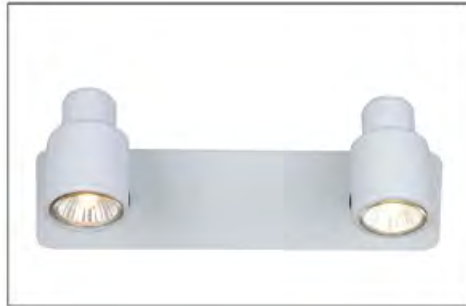

MSW-S038



MSW-S042



MSW-S046

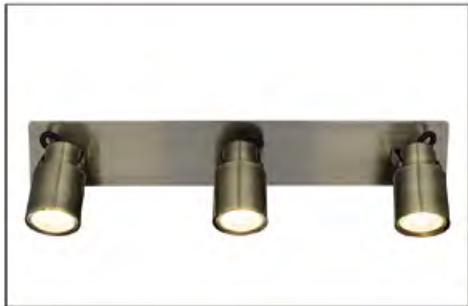

MSW-S035



MSW-S039



MSW-S043



MSW-S047



MSW-S036



MSW-S040



MSW-S044



MSW-S048



MSW-S049



MSW-S053



MSW-S057



MSW-S061



MSW-S050



MSW-S054



MSW-S058



MSW-S062



MSW-S051



MSW-S055



MSW-S059



MSW-S063



MSW-S052



MSW-S056



MSW-S060



MSW-S064



MSW-S068



MSW-S072



MSW-S076



MSW-S065



MSW-S069



MSW-S073



MSW-S077



MSW-S066



MSW-S070



MSW-S074



MSW-S078

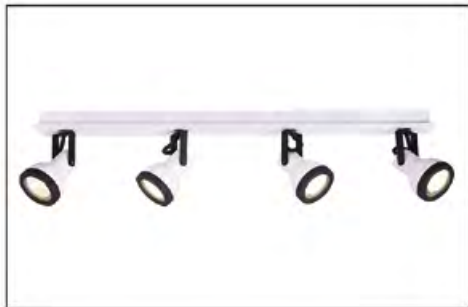

MSW-S067



MSW-S071



MSW-S075



MSW-S079

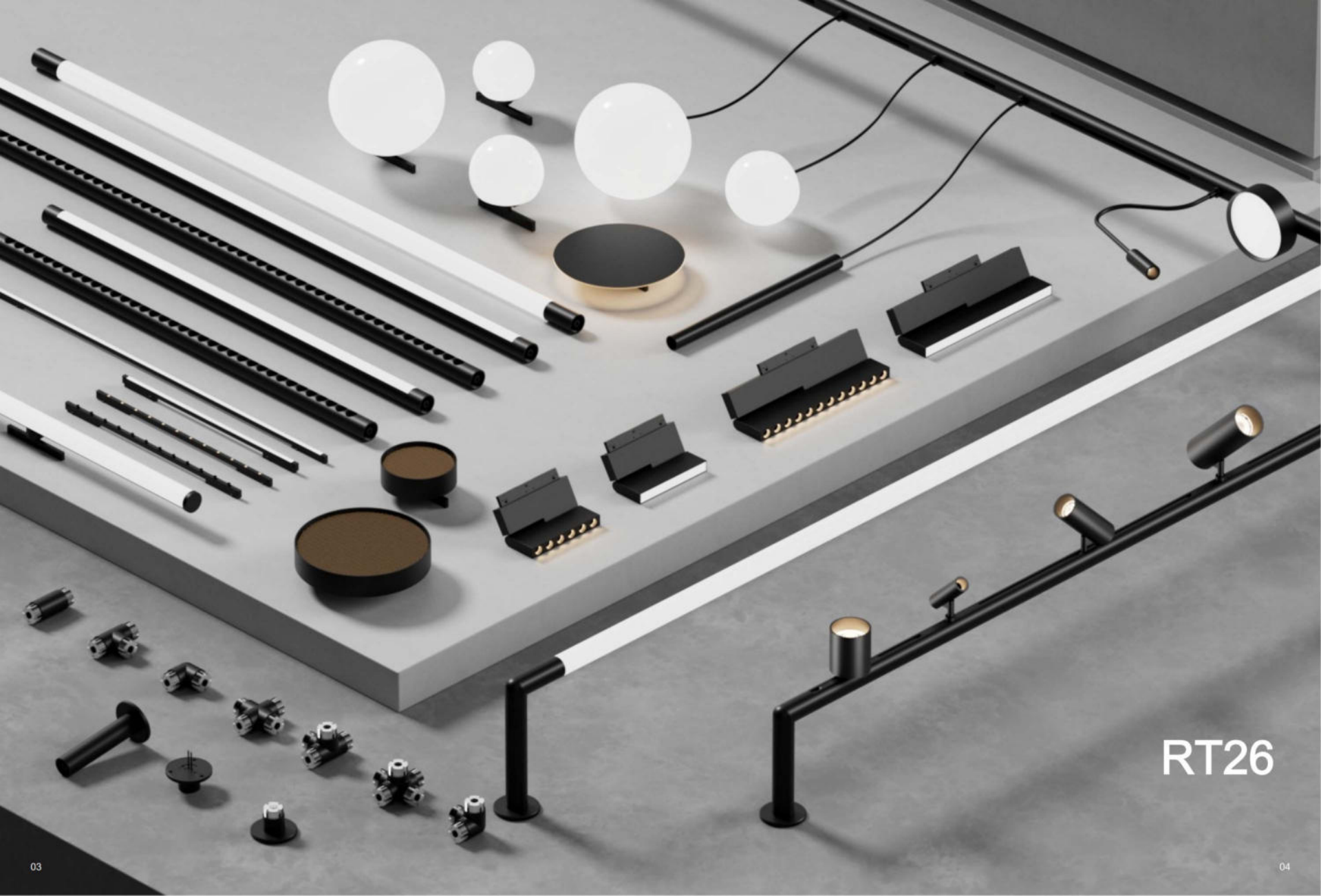

RT26

TB-24V 灯具及轨道

TB-24V Luminaires & track

TB 系统只需一套系统即可满足各种照明需求它可以与 TB-DFS、TB-GLR 和 TB-PC 等线性灯具组合使用，营造出独特的照明效果，为了获得最佳的办公室照明效果，TB-track 可与 Nano (5 毫米) 系统灯具插件组合使用从而为照明设计带来更大的灵活性

TB system fulfils a wide range of lighting requirements with just one system. It can be combine with TB-DFS, TB-GLR and TB-PC these linear luminaires achieve for a special effect. For optimum office lighting, TB-track can be combine with Nano (5mm) system luminaires inserts for even more flexibility in lighting design.



RT26

Material - Extruded aluminum profile
Surface treatment - Available in white, black
Powder coating of other colors, can be customized upon request. You can cut by yourself
Size - Diameter 26.6" Length 1000/1500/2000 Other sizes can be customized upon request.



RT26-O-1M/1.5M/2M

Material - Extruded aluminum profile with built-in pure copper wire guide
Surface treatment - Available in white, black
Powder coating of other colors, customizable upon request.
Size - Diameter 26.6" Length 1020/1500/2000 Other sizes can be customized upon request.



RT26-18T/36T/54T

Material - aluminum extruded
Finished - with selection of white, black & other colors powder coating finishes on requested.
Wattage - 8/18/24W
Beam Angle - 35°
CCT - 3000K 4000K 5000K
Size - L374*D26.6/L700*D26.6/L1020*D26.6



RT26-370/700F/1000F

Material - aluminum extruded
Finished - with selection of white, black & other colors powder coating finishes on requested.
Wattage - 8/12/24W
Beam Angle - 120°
CCT - 3000K 4000K 5000K
Size - L374*D26.6/L700*D26.6/L1020*D26.6

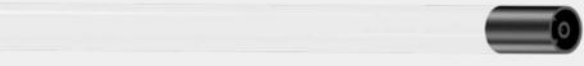

RT26-TUBE370/700/1000

Material - aluminum extruded
Finished - with selection of white, black & other colors powder coating finishes on requested.
Wattage - 6/12/18W
Beam Angle - 360°
CCT - 3000K 4000K 5000K
Size - L374*D26.6/L700*D26.6/L1020*D26.6

管道通过简单的旋转、插入实现电气和机械连接，这使得复杂照明系统的安装极其简单、快速和直接。

The pipes are connected electrically and mechanically by simply twisting and inserting. This makes the installation of complex lighting systems extremely simple, fast and straightforward.



TUBO 系统灯具实现 360° 配光和乳白色灯罩，可实现均匀照明，并略微提升地区亮度。

这使得该系统灯具非常适合需要营造舒适环境

照明的场所



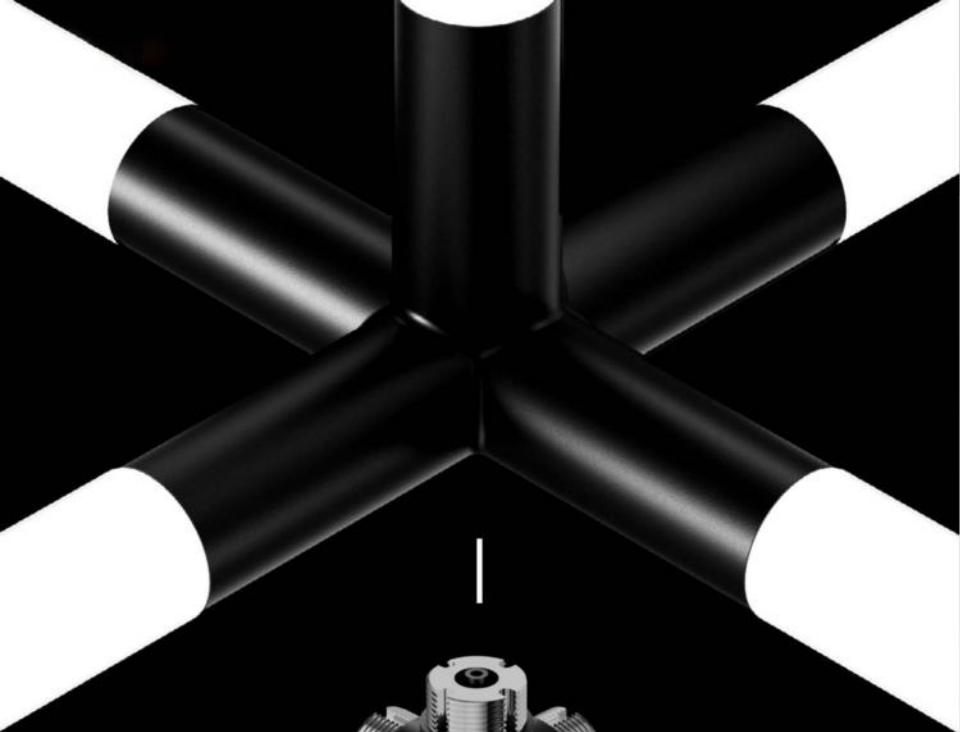









TUBO system luminaires offer 360° light distribution and opalescent shades for even illumination and slightly brighter areas. This makes them ideal for locations that require comfortable ambient lighting



由于 L 形、T 形和 X 形的机械和电气连接元件种类繁多，因此具有最大的设计自由度。借助 TB 连接系统，可以轻松实现几何形状、迷人的灯光雕塑以及不同空间要求的满足。

Thanks to the wide range of mechanical and electrical connection elements such as I-type, L-type, T-type, X-type and 4D connectors, there is a high degree of design freedom. Geometric shapes, fascinating light sculptures and the need to meet different spatial requirements can be easily realized.



- | | | | | |
|---|---|---|--|---|
|  | <p>型号 /Model
RT26-O-AD
材料 /Material
铝材 /Aluminum</p> |  | <p>型号 /Model
RT26-O-AD
材料 /Material
铝材 /Aluminum</p> | |
|  | <p>型号 /Model
RT26-O-I
材料 /Material
铝材 /Aluminum</p> |  | <p>型号 /Model
RT26-O-L
材料 /Material
铝材 /Aluminum</p> | |
|  | <p>型号 /Model
RT26-O-Y
材料 /Material
铝材 /Aluminum</p> |  | <p>型号 /Model
RT26-O-十
材料 /Material
铝材 /Aluminum</p> |  |
|  | <p>型号 /Model
RT26-O-5way
材料 /Material
铝材 /Aluminum</p> |  | <p>型号 /Model
RT26-Base-A
材料 /Material
铝材 /Aluminum</p> |  |
|  | <p>型号 /Model
RT26-power supply 150W
材料 /Material
铝材 /Aluminum</p> |  | <p>型号 /Model
RT26-Base-C
材料 /Material
铝材 /Aluminum</p> |  |
| | | | | <p>型号 /Model
RT26-O-T
材料 /Material
铝材 /Aluminum</p> |
| | | | | <p>型号 /Model
RT26-O-T
材料 /Material
铝材 /Aluminum</p> |
| | | | | <p>型号 /Model
RT26-Base-B
材料 /Material
铝材 /Aluminum</p> |



RT26-O-AD 具有 200° 水平旋转和 360° 旋转连接器，控制灯光方向，还可以形成无数种形状，让场景设计感更加得丰富自如，

RT26-O-AD has 200° horizontal rotation and 360° rotating connector to control the direction of the light. It can also form countless shapes, making the scene design more rich and free.

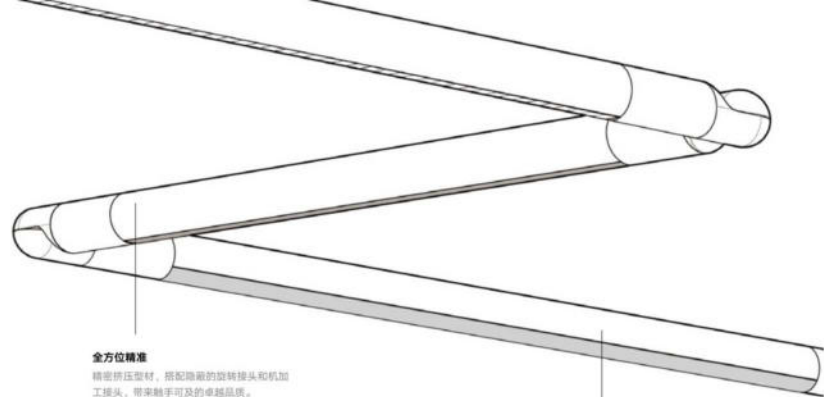

全方位精准

精密挤压型材，搭配精密的旋转接头和机加工接头，带来触手可及的卓越品质。

ALL AROUND PRECISION

Precision extruded profile with discreet swivels and machined joiners for premium quality you can touch and see.

适应任何空间

易于重新配置的表面和连接系统可以成为任何空间的理想选择，从极简主义的建筑走廊到新一代的蛇形楼梯。

ALL AROUND PRECISION

The easily reconfigurable end cap and connection system can be ideal for any space, from a minimalist architectural corridor to a new generation of serpentine staircases.

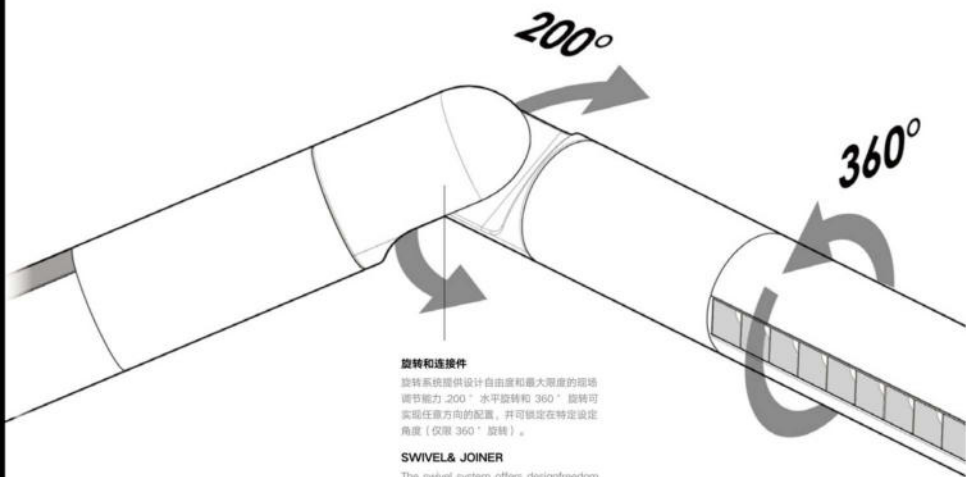

旋转和连接件

旋转系统提供设计自由度和最大限度的现场调整能力。200° 水平旋转和 360° 旋转可实现任意方向的配置，并可锁定在特定设置角度（仅限 360° 旋转）。

SWIVEL & JOINER

The swivel system offers design freedom and maximum on-site adjust-ability. The horizontal rotation of 200° and a full 360° rotation swivel enables configuration in any desired direction and can be locked in specific set angle (360° rotation only).





无限变换, 以下是我们探索出的形状和图案,
还有更多丰富的形状等着你去创造。

Infinite transformations, the following are the
shapes and patterns we explored, and more rich
shapes are waiting for you to create.



激活光的万千形态, 重塑你的空间想象
从极简线条到星河璀璨, 更多惊艳光影

Activate the myriad forms of light and reshape
your spatial imagination.
From minimalist lines to brilliant stars, more
stunning light and shadow.













线性格栅灯

LINEAR GRILLE LIGHTS



线性泛光灯

LINEAR FLOODLIGHT



折叠格栅灯

FOLDING GRILLE LIGHTS



折叠泛光灯

FOLDING FLOODLIGHT

UNS-12T

尺寸 / SIZE (MM)



功率 / Power

6W

光束角 / Beam angle

60°

色温 / CCT

3000K/4000K/6000K

UNS-300F

尺寸 / SIZE (MM)



功率 / Power

9W

光束角 / Beam angle

120°

色温 / CCT

3000K/4000K/6000K

UNS-600F

尺寸 / SIZE (MM)



功率 / Power

18W

光束角 / Beam angle

120°

色温 / CCT

3000K/4000K/6000K

UNS-ZD-6T

尺寸 / SIZE (MM)



功率 / Power

6W

光束角 / Beam angle

24°

色温 / CCT

3000K/4000K/6000K

UNS-ZD-12T

尺寸 / SIZE (MM)



功率 / Power

12W

光束角 / Beam angle

24°

色温 / CCT

3000K/4000K/6000K

UNS-ZD-6F

尺寸 / SIZE (MM)



功率 / Power

6W

光束角 / Beam angle

120°

色温 / CCT

3000K/4000K/6000K

UNS-ZD-12F

尺寸 / SIZE (MM)



功率 / Power

12W

光束角 / Beam angle

120°

色温 / CCT

3000K/4000K/6000K

灯体颜色 / Light Color

黑色 / Black

通用规格 / General specifications

灯体材料 / Material 铝材 / Aluminum

扩散罩材料 / Diffuser Lens

防护等级 / IP IP20

工作温度 / Warranty -25 ° C - 50 ° C

质保 / Warranty 5 YEARS

电压 / Voltage 24V

灯体颜色 / Light Color

黑色 / Black

通用规格 / General specifications

灯体材料 / Material 铝材 / Aluminum

扩散罩材料 / Diffuser Lens

防护等级 / IP IP20

工作温度 / Warranty -25 ° C - 50 ° C

质保 / Warranty 5 YEARS

电压 / Voltage 24V



轨道射灯
TRACK LIGHTS



圆球灯
TRACK BALL LAMP



双层玻璃球
DOUBLE LAYERED GLASS BALL



轨道式-月球
TRACK TYPE -MOON
UN5-GDD150



轨道式-地球
TRACK TYPE -EARTH
UN5-GDY150

UN5-L20
尺寸 / SIZE (MM)



功率 / Power

3W

光束角 / Beam angle

24°

色温 / CCT

3000K/4000K/6000K

扩散罩材料 / Diffuser

Lens

UN5-L33
尺寸 / SIZE (MM)



功率 / Power

6W

光束角 / Beam angle

24°

色温 / CCT

3000K/4000K/6000K

扩散罩材料 / Diffuser

Lens

UN5-L43
尺寸 / SIZE (MM)



功率 / Power

12W

光束角 / Beam angle

24°

色温 / CCT

3000K/4000K/6000K

扩散罩材料 / Diffuser

Lens

UN5-P95
尺寸 / SIZE (MM)



功率 / Power

6W

光束角 / Beam angle

180°

色温 / CCT

3000K/4000K/6000K

扩散罩材料 / Diffuser

Glass

UN5-B60
尺寸 / SIZE (MM)



功率 / Power

6W

光束角 / Beam angle

150°

色温 / CCT

3000K/4000K/6000K

扩散罩材料 / Diffuser

Glass

UN5-GDD150/UN5-GDY150
尺寸 / SIZE (MM)



功率 / Power

6W

光束角 / Beam angle

350°

色温 / CCT

3000K/4000K/6000K

扩散罩材料 / Diffuser

Plastic

灯体颜色 / Light Color

黑色 / Black

通用规格 / General specifications

灯体材料 / Material 铝材 / Aluminum

防护等级 / IP IP20

工作温度 / Warranty -25° C-50° C

质保 / Warranty 5 YEARS

电压 / Voltage 24V

灯体颜色 / Light Color

黑色 / Black

通用规格 / General specifications

灯体材料 / Material 铝材 / Aluminum

防护等级 / IP IP20

工作温度 / Warranty -25° C-50° C

质保 / Warranty 5 YEARS

电压 / Voltage 24V



明装圆形射灯

SURFACE MOUNTED SPOTLIGHTS



日蚀壁灯

SOLAR ECLIPSE WALL LAMP

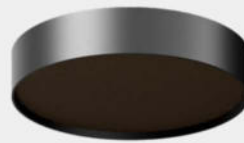

明装泛光灯

SURFACE MOUNTED FLOODLIGHT

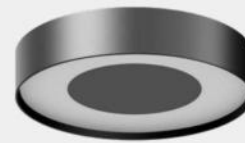

明装圆形射灯

SURFACE MOUNTED SPOTLIGHTS 9 IN 1

UN5-TD50

尺寸 / SIZE (MM)



功率 / Power

6W

光束角 / Beam angle

24°

色温 / CCT

3000K/4000K/6000K

扩散罩材料 / Diffuser

Lens

UN5-YSBD

尺寸 / SIZE (MM)



功率 / Power

9W

光束角 / Beam angle

150°

色温 / CCT

3000K/4000K/6000K

扩散罩材料 / Diffuser

PC

UN5-WB90

尺寸 / SIZE (MM)



功率 / Power

9W

光束角 / Beam angle

120°

色温 / CCT

3000K/4000K/6000K

扩散罩材料 / Diffuser

Lens

UN5-WB168

尺寸 / SIZE (MM)

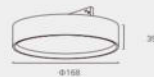

功率 / Power

18W

光束角 / Beam angle

120°

色温 / CCT

3000K/4000K/6000K

扩散罩材料 / Diffuser

Lens

UN5-G90

尺寸 / SIZE (MM)



功率 / Power

9W

光束角 / Beam angle

24°

色温 / CCT

3000K/4000K/6000K

扩散罩材料 / Diffuser

Lens

灯体颜色 / Light Color

黑色 / Black

通用规格 / General specifications

灯体材料 / Material 铝材 / Aluminum

扩散罩材料 / Diffuser Lens

防护等级 / IP IP20

工作温度 / Warranty -25° C-50° C

质保 / Warranty 5 YEARS

电压 / Voltage 24V

灯体颜色 / Light Color

黑色 / Black

通用规格 / General specifications

灯体材料 / Material 铝材 / Aluminum

防护等级 / IP IP20

工作温度 / Warranty -25° C-50° C

质保 / Warranty 5 YEARS

电压 / Voltage 24V



直式悬吊灯
HOISTING-STRAIGHT CYLINDER



直式悬圆球灯
SUSPENDED SPHERICAL LAMP



地球
SURFACE MOUNTED SPOTLIGHTS
UN5-D150



月球
SURFACE MOUNTED SPOTLIGHTS
UN5-Y150



轨道式阅读灯
TRACK TYPE READING LIGHT

UN5-30D300

尺寸 / SIZE (MM)



功率 / Power

6W

光束角 / Beam angle

24°

色温 / CCT

3000K/4000K/6000K

扩散罩材料 / Diffuser

Lens

UN5-DP95

尺寸 / SIZE (MM)



功率 / Power

6W

光束角 / Beam angle

180°

色温 / CCT

3000K/4000K/6000K

扩散罩材料 / Diffuser

PC

UN5-D150/Y150

尺寸 / SIZE (MM)



功率 / Power

6W

光束角 / Beam angle

350°

色温 / CCT

3000K/4000K/6000K

扩散罩材料 / Diffuser

Plastic

UN5-YDL20

尺寸 / SIZE (MM)



功率 / Power

3W

光束角 / Beam angle

24°

色温 / CCT

3000K/4000K/6000K

扩散罩材料 / Diffuser

Lens

灯体颜色 / Light Color

黑色 / Black

通用规格 / General specifications

灯体材料 / Material	铝材 / Aluminum
防护等级 / IP	IP20
工作温度 / Warranty	-25° C-50° C
质保 / Warranty	5 YEARS
电压 / Voltage	24V

灯体颜色 / Light Color

黑色 / Black

通用规格 / General specifications

灯体材料 / Material	铝材 / Aluminum
防护等级 / IP	IP20
工作温度 / Warranty	-25° C-50° C
质保 / Warranty	5 YEARS
电压 / Voltage	24V

软性线条灯
SOFT LINEAR LAMP

UN5-GJXT1000
尺寸 / SIZE (MM)



功率 / Power

10W

光束角 / Beam angle

180°

色温 / CCT

3000K/4000K/6000K

UN5-GJXT2000
尺寸 / SIZE (MM)



功率 / Power

20W

光束角 / Beam angle

180°

色温 / CCT

3000K/4000K/6000K

UN5-GJXT3000
尺寸 / SIZE (MM)



功率 / Power

30W

光束角 / Beam angle

180°

色温 / CCT

3000K/4000K/6000K

灯体颜色 / Light Color

黑色 / Black

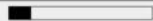

通用规格 / General specifications

灯体材料 / Material	硅胶 / Silica gel
扩散罩材料 / Diffuser	硅胶 / Silica gel
防护等级 / IP	IP20
工作温度 / Warranty	-25 ° C - 50 ° C
质保 / Warranty	5 YEARS
电压 / Voltage	24V



金刚棒 - 泛光灯
STICK - FLOODLIGHT

UN5-SS300F
尺寸 / SIZE (MM)



功率 / Power

9W

光束角 / Beam angle

24°

色温 / CCT

3000K/4000K/6000K

UN5-SS600F
尺寸 / SIZE (MM)



功率 / Power

18W

光束角 / Beam angle

24°

色温 / CCT

3000K/4000K/6000K

UN5-SS900F
尺寸 / SIZE (MM)



功率 / Power

27W

光束角 / Beam angle

24°

色温 / CCT

3000K/4000K/6000K

灯体颜色 / Light Color

黑色 / Black



通用规格 / General specifications

灯体材料 / Material	铝材 / Aluminum
扩散罩材料 / Diffuser	Lens
防护等级 / IP	IP20
工作温度 / Warranty	-25 ° C - 50 ° C
质保 / Warranty	5 YEARS
电压 / Voltage	24V

Host
Sub Unit

轨道蓝牙音响有主副机两种模式
可以通过设备后盖拨码来切换主机与副机
1个主机可以带动N...个副机

The Track Bluetooth Speaker has two modes of Host and Sub Unit, which can be switched between the Host and Sub Unit by dip switch on the back cover of the device.

One Host can drive N... Sub Unit

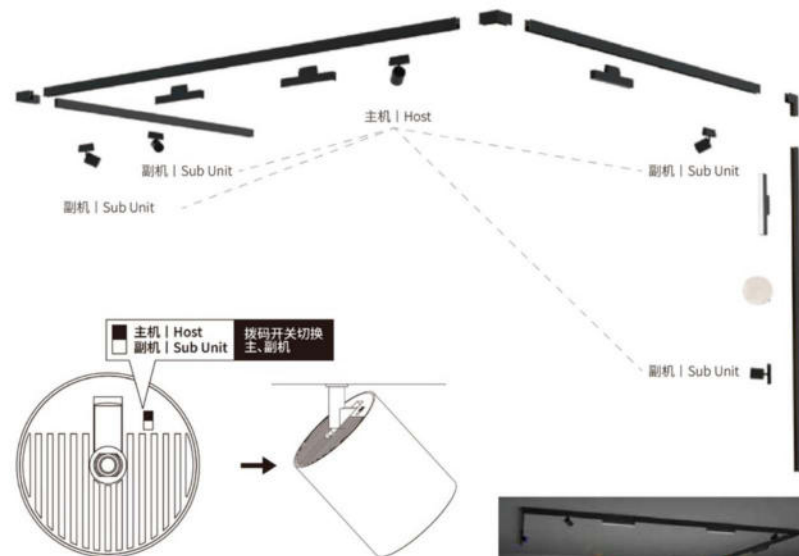

蓝牙设备连接主机模式的轨道蓝牙音响
其他副机模式自动同步连接
1个主机可以带动N...个副机

Bluetooth device connect to the Host mode,
Track Bluetooth Speaker and other Sub Unit
modes automatically synchronize and connect.
One Host can drive N... Sub Unit



蓝牙设备
打开蓝牙搜索



主机 | Host

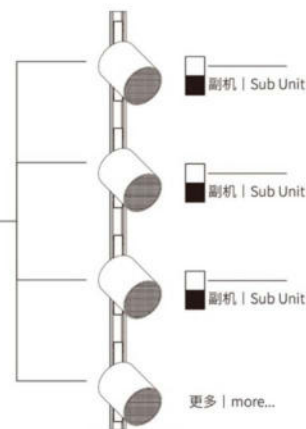

更多 | more...

轨道蓝牙音响

Track Bluetooth speaker



轨道蓝牙音响
TRACK BLUETOOTH SPEAKER

UN5-30D300

尺寸 / SIZE (MM)



功率 / Power

10W

电压 / Voltage

DC24V-48V/AC85V-265V

蓝牙版本 / Bluetooth Version

V5.4

信号频率 / Signal Frequency

120B

主副机距离 / Distance Between Host & Sub Unit

20米无障碍 / 20 meters barrier-free

材质 / Material

PC

防护等级 / Protection class

IP20

使用环境温度 / Ambient temperature

-20° C-40C

Bluetooth Speaker    

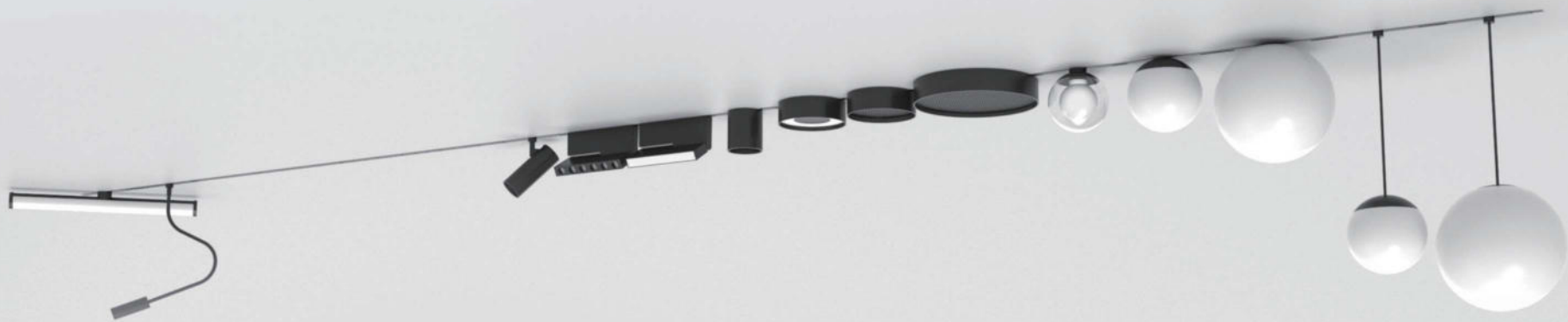

5mm宽度 超窄轨道系列
Ultra-narrow magnetic track system
5mm wide

5mm宽度 超窄轨道系列
Ultra-narrow magnetic track system

5mm wide





吊装轨道条 | Hanging-track

型号 | Model
UNS-C

用途 | Use
明装或悬吊 | Surface mounted or Hanging

材质 | Material
铝材 | Aluminum product

颜色 | Body Color
黑色 | Black

电压 | Voltage
DC24V

功率 | Power
200w (MAX)







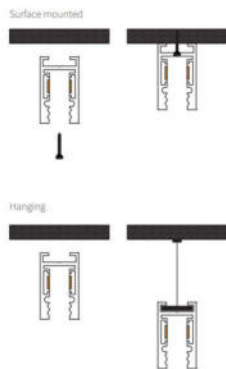
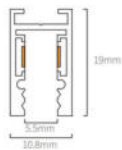

防护等级 | Protection class
IP20

使用环境温度 | Ambient temperature
-20°C~40°C

规格 | Size
1000*10.8*19mm 
2000*10.8*19mm 
3000*10.8*19mm 



搭配零件 | Matching parts

<p>常规配置 Conventional configuration</p>	 轨道末端堵头 Track end plug	 轨道防尘罩 Track dust cover	 吊线包 Hanging wire package
<p>轨道拼接件 Track splicing components</p>	 轨道拼接件 Track connect components		
<p>轨道转角模块 Track angle module</p>	 水平弯接 Horizontal Angle	 垂直弯接 Vertical Angle	
<p>轨道导电模块 Track conducting module</p>	 双头软接&双头直接 Bidirectional conductive module	 输入模块 Input module	



嵌入式暗装轨道条 | Recessed track

型号 | Model
UNS-D

用途 | Use
嵌入式 | Recessed

材质 | Material
铝材 | Aluminum product

颜色 | Body Color
黑色 | Black

电压 | Voltage
DC24V

功率 | Power
200w (MAX)



防护等级 | Protection class
IP20

使用环境温度 | Ambient temperature
-20°C~40°C

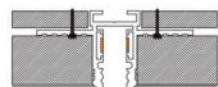
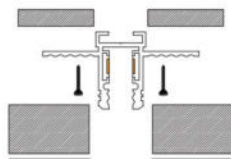
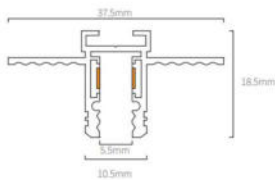
规格 | Size
1000*38*19mm
2000*38*19mm
3000*38*19mm



搭配零件 | Matching parts

常规配置 Conventional configuration	 轨道末端堵头 Track end plug	 轨道防尘罩 Track dust cover
轨道拼接件 Track splicing components	 轨道拼接件 Track connect components	
轨道转角模块 Track angle module	 水平弯接 Horizontal Angle	 垂直弯接 Vertical Angle
轨道导电模块 Track conducting module	 双头软接&双头直接 Bidirectional conductive module	 输入模块 Input module

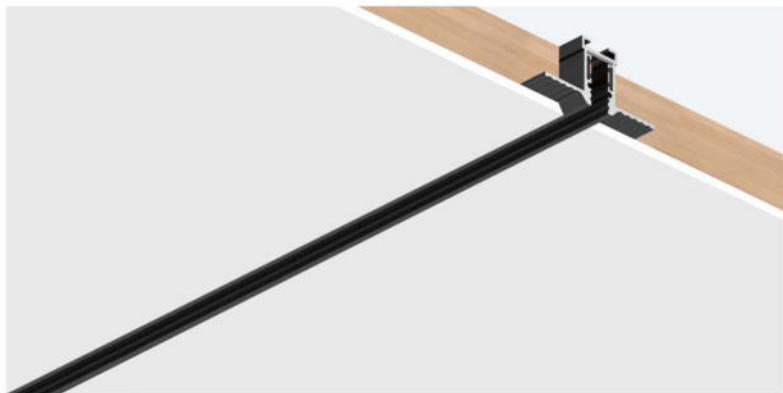

批灰轨道条 | Batch ash track

型号 | Model
UNS-E

用途 | Use
嵌入式 | Recessed

材质 | Material
铝材 | Aluminum product

颜色 | Body Color
黑色 | Black

电压 | Voltage
DC24V

功率 | Power
200w (MAX)

防护等级 | Protection class
IP20

使用环境温度 | Ambient temperature
-20°C~40°C

规格 | Size
1000*38*19mm
2000*38*19mm
3000*38*19mm

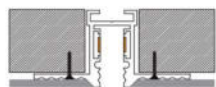
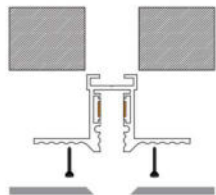
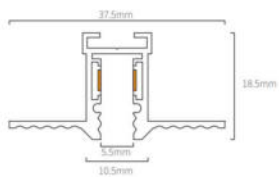

搭配零件 | Matching parts

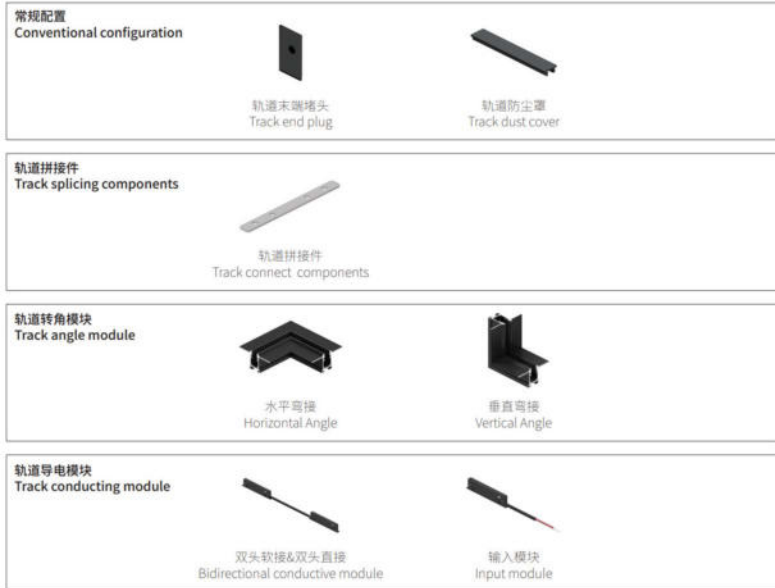



圆形吊装轨道 | Circular lifting track

型号 | Model
UNS-O

用途 | Use
悬吊 | Hanging

材质 | Material
铝材 | Aluminum product

颜色 | Body Color
黑色 | Black

电压 | Voltage
DC24V

功率 | Power
200w (MAX)





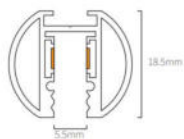

防护等级 | Protection class
IP20

使用环境温度 | Ambient temperature
-20°C~40°C

规格 | Size
1000*22*18mm 
2000*22*18mm 
3000*22*18mm 



搭配零件 | Matching parts

常规配置 Conventional configuration	 轨道末端堵头 Track end plug	 轨道防尘罩 Track dust cover	 吊线包 Hanging wire package
轨道拼接件 Track splicing components	 轨道拼接件 Track connect components		
轨道转角模块 Track angle module	 水平弯接 Horizontal Angle		
轨道导电模块 Track conducting module	 双头软接&双头直接 Bidirectional conductive module	 输入模块 Input module	



双面吊装轨道 | Double sided lifting track

型号 | Model
UNS-H

用途 | Use
悬吊 | Hanging

材质 | Material
铝材 | Aluminum product

颜色 | Body Color
黑色 | Black

电压 | Voltage
DC24V

功率 | Power
200w (MAX)

防护等级 | Protection class
IP20

使用环境温度 | Ambient temperature
-20°C~40°C

规格 | Size
1000*11*33mm 
2000*11*33mm 
3000*11*33mm 

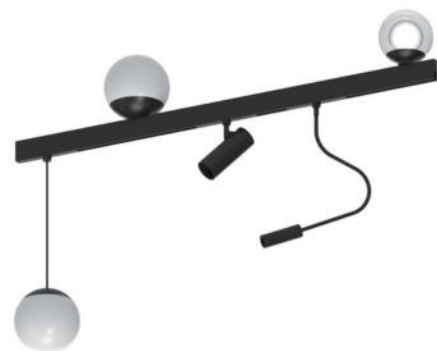
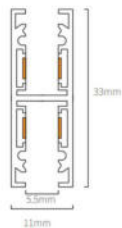

搭配零件 | Matching parts

常规配置 Conventional configuration	 轨道末端堵头 Track end plug	 轨道防尘罩 Track dust cover	 吊线包 Hanging wire package
轨道拼接件 Track splicing components	 轨道拼接件 Track connect components		
轨道转角模块 Track angle module	 水平弯接 Horizontal Angle		
轨道导电模块 Track conducting module	 双头软接&双头直接 Bidirectional conductive module	 输入模块 Input module	



超薄软膜天花轨道条 | Ceiling soft film track

型号 | Model
UNS-RM

用途 | Use
吊装固定式 | Lifting fixing

材质 | Material
铝材 | Aluminum product

颜色 | Body Color
黑色 | Black

电压 | Voltage
DC24V

功率 | Power
200w (MAX)

防护等级 | Protection class
IP20

使用环境温度 | Ambient temperature
-20°C~40°C

规格 | Size
1000*42*38mm 
2000*42*38mm 
3000*42*38mm 

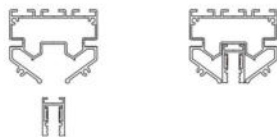
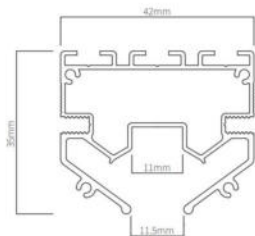

搭配零件 | Matching parts

常规配置 Conventional configuration	 轨道末端堵头 Track end plug	 固定角码 Mounting part	 硅胶条 Silicone strip	 吊装轨道条 Hanging-track
轨道拼接件 Track splicing components	 转角加固件 Angle reinforcement	 直接加固件 Direct reinforcement		
轨道转角模块 Track angle module	 水平弯接 Horizontal Angle			
轨道导电模块 Track conducting module	 双头软接&双头直接 Bidirectional conductive module	 输入模块 Input module		



双头软接&双头直接 | Bidirectional conductive module

型号 | Model
UNS-RJ

用途 | Use
I型或转角双向导电模块 | Type I or Angle bidirectional conductive module

材质 | Material
塑料 | plastic

颜色 | Body Color
黑色 | Black

电压 | Voltage
DC24V

功率 | Power
200w (MAX)

防护等级 | Protection class
IP20

使用环境温度 | Ambient temperature
-20°C~40°C

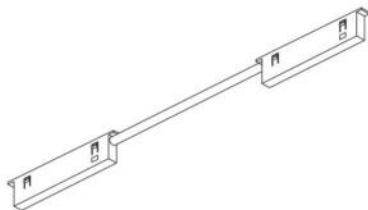

输入模块 | Input module

型号 | Model
UNS-SRMK

用途 | Use
线末端接外置变压器 | The end of the line is connected to the external transformer

材质 | Material
塑料 | plastic

颜色 | Body Color
黑色 | Black

电压 | Voltage
DC24V

功率 | Power
200w (MAX)

防护等级 | Protection class
IP20

使用环境温度 | Ambient temperature
-20°C~40°C

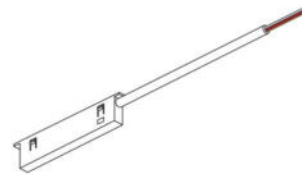

3 CCT

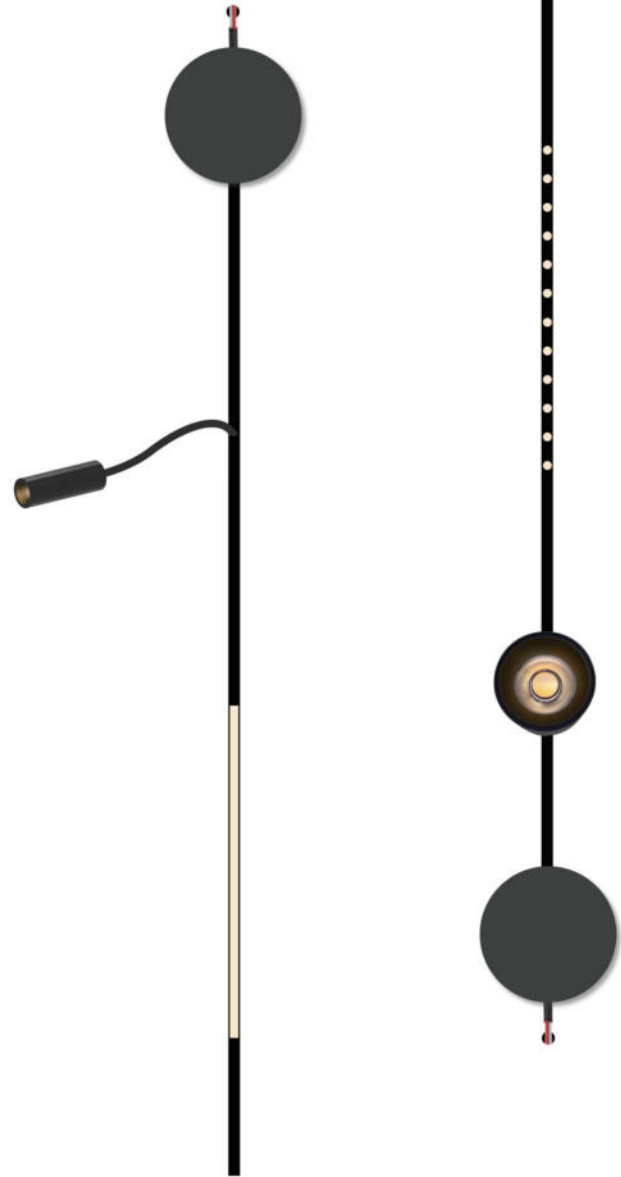
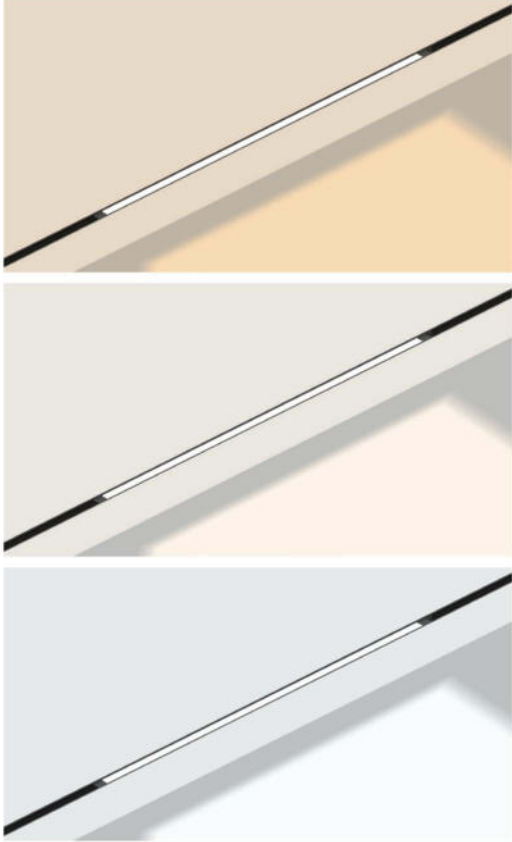

单色温灯具常规接线
Conventional wiring of monochrome temperature lamps

单色灯具-一体电源 | Monochrome lamps - integrated power supply



单色温灯具-可控硅, 0-10V, DALI群组控制调光接线
Monochrome temperature luminaires - TRAIC, 0-10V, DALI group control dimming wiring

单色灯具-接外置可控硅 | Monochrome lamps - Connected with external TRAIC

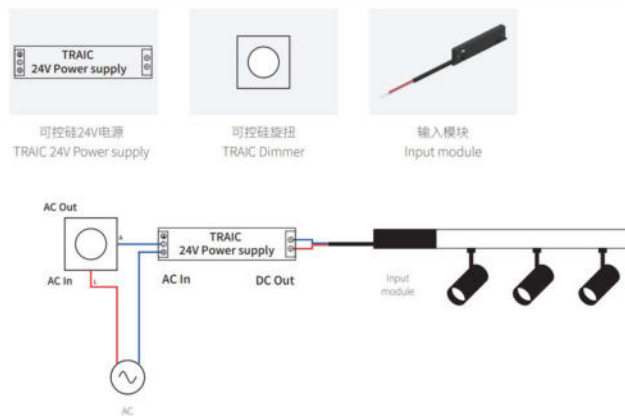

单色灯具-外接变压器 | Monochrome lamps - External transformer

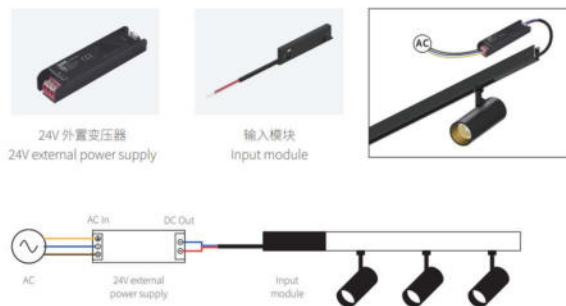

单色灯具-接外置0-10V | Monochrome lamps - Connected with external 0-10V Dimming

单色灯具-接外置DALI | Monochrome lamps - Connected with external DALI Dimming

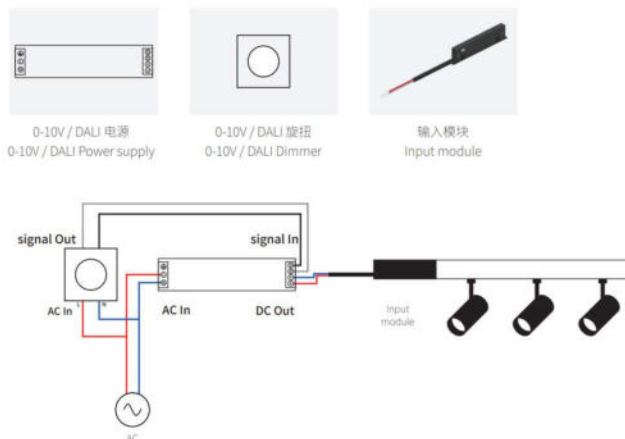

双色温灯具内置智能电源群组控制调光调色温
3CCT lamps built-in intelligent power group control dimming color temperature

双色灯具-一体智能电源 | 3CCT luminaire - integrated intelligent power supply

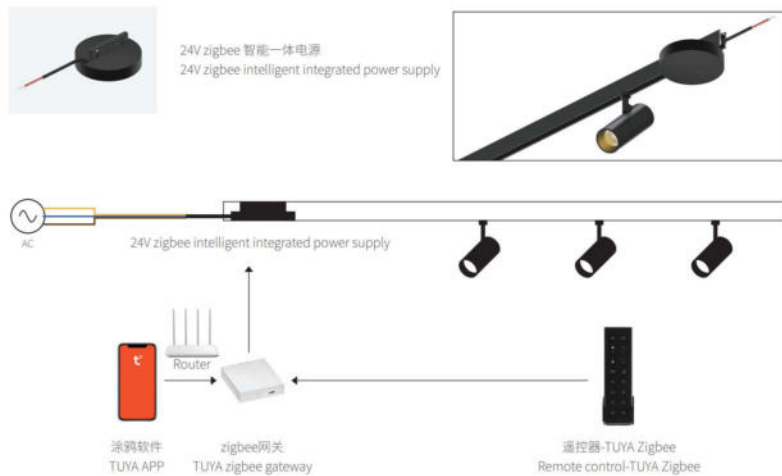
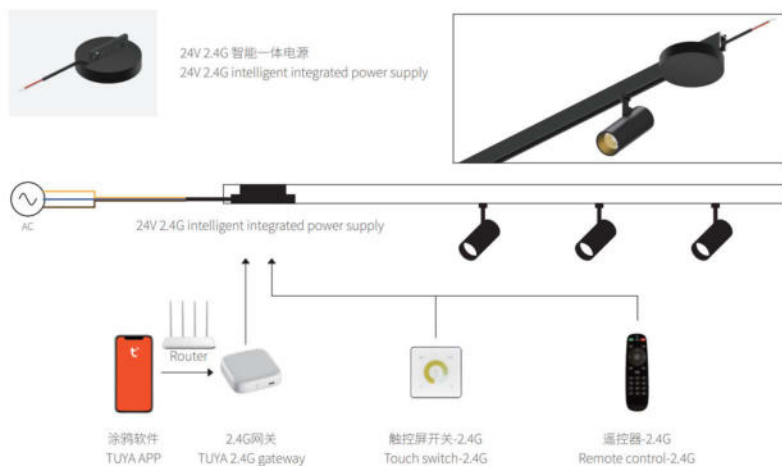

双色温灯具外置智能电源群组控制调光调色温
3CCT lamps external intelligent power supply group control dimming color temperature

双色灯具-接外置变压器和外置控制器 | 3CCT luminaire - Connect an external transformer and an external controller

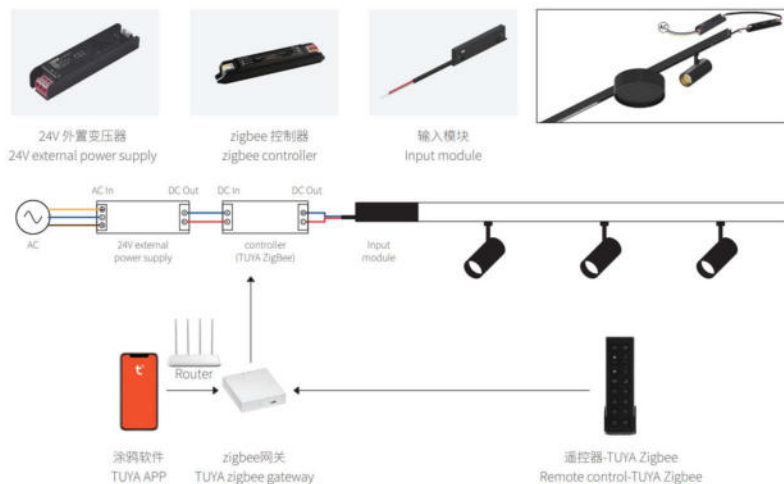
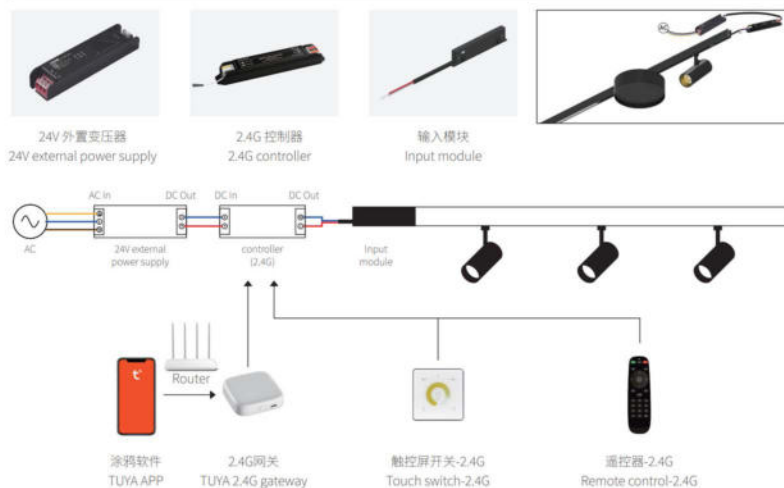

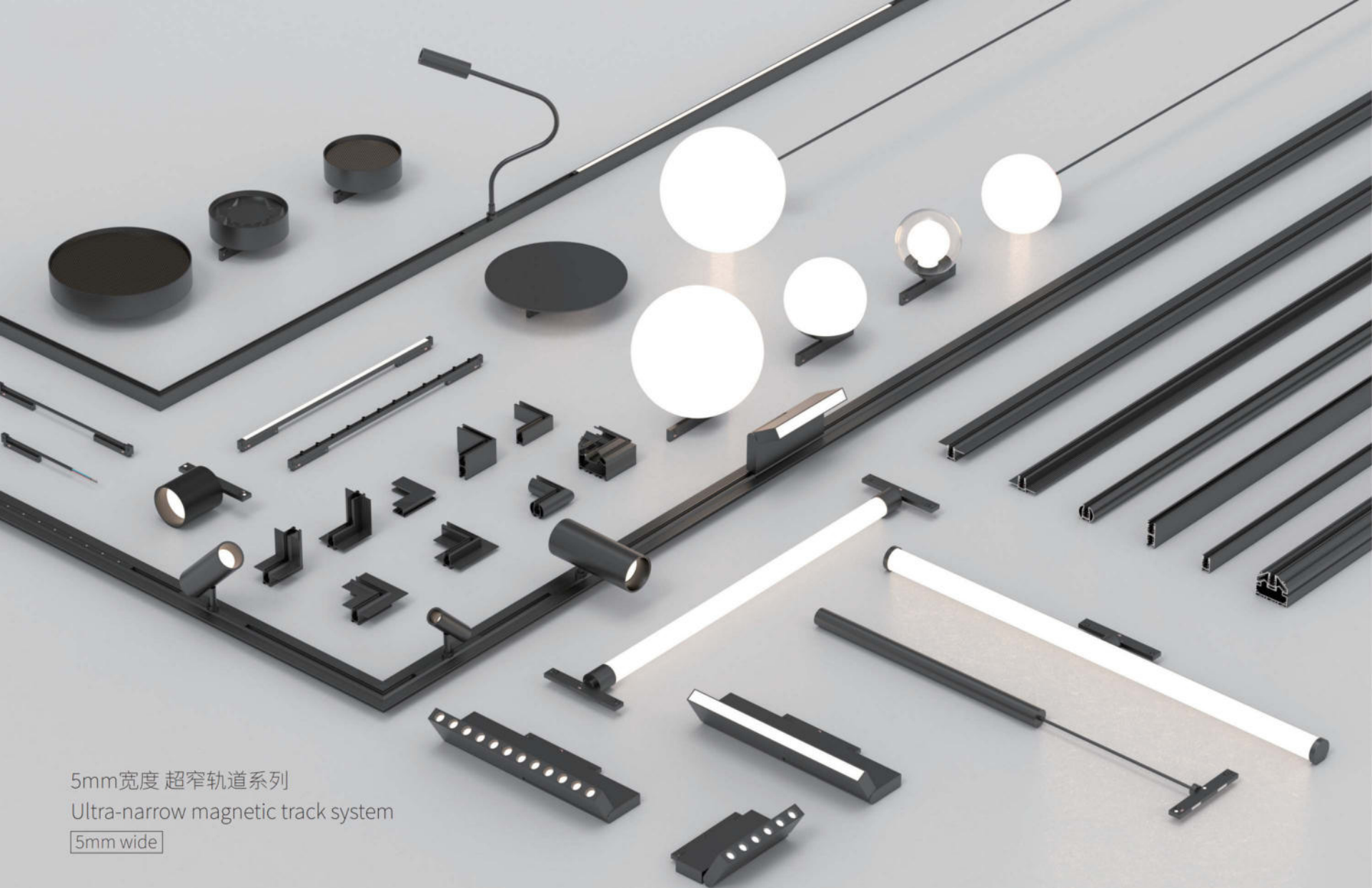

5mm宽度 超窄轨道系列
Ultra-narrow magnetic track system

5mm wide



5mm宽度 超窄轨道系列-灯具展示
Ultra-narrow magnetic track system-lamp show

5mm wide



线条格栅灯 | Grille light 12 in 1

型号 | Model

UNS-12T

尺寸 | size

L300*W5*H14mm

功率 | Power

9W

扩散罩 | Diffuser

透镜 | lens

发光角度 | Luminous Angle

24°

色温 | Temperature

3000K / 4000K / 6000K

电压 | Voltage

DC24V

材质 | Material

铝材 | Aluminum product

颜色 | Body Color

黑色 | Black

防护等级 | Protection class

IP20

使用环境温度 | Ambient temperature

-20°C~40°C





线条泛光灯 | Floodlight light

① 型号 | Model

UNS-300F

尺寸 | size

L300*W5*H14mm

功率 | Power

9W

扩散罩 | Diffuser

PC

发光角度 | Luminous Angle

120°

色温 | Temperature

3000K / 4000K / 6000K

电压 | Voltage

DC24V

材质 | Material

铝材 | Aluminum product

颜色 | Body Color

黑色 | Black

防护等级 | Protection class

IP20

使用环境温度 | Ambient temperature

-20°C~40°C

② 型号 | Model

UNS-600F

尺寸 | size

L600*W5*H14mm

功率 | Power

18W





5mm宽度 超窄轨道系列-灯具展示
Ultra-narrow magnetic track system-lamp show

5mm wide



线条格栅灯 | Grille light

① 型号 | Model

UNS-LC6T

尺寸 | size

L118*W15*H36mm

功率 | Power

6W

扩散罩 | Diffuser

透镜 | lens

发光角度 | Luminous Angle

24°

色温 | Temperature

3000K / 4000K / 6000K

电压 | Voltage

DC24V

材质 | Material

铝材 | Aluminum product

颜色 | Body Color

黑色 | Black

防护等级 | Protection class

IP20

使用环境温度 | Ambient temperature

-20°C~40°C

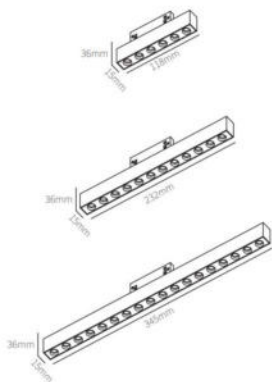

② 型号 | Model

UNS-LC12T

尺寸 | size

L232*W15*H36mm

功率 | Power

12W

③ 型号 | Model

UNS-LC18T

尺寸 | size

L345*W15*H36mm

功率 | Power

18W



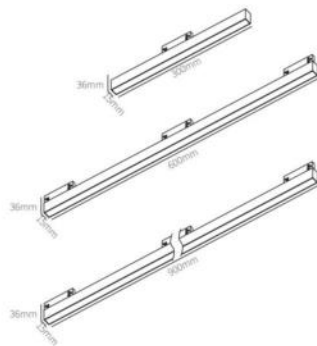

线条泛光灯 | Floodlight light

1 型号 | Model

UNS-LC300F

尺寸 | size

L300*W15*H36mm

功率 | Power

9W

扩散罩 | Diffuser

PC

发光角度 | Luminous Angle

24°

色温 | Temperature

3000K / 4000K / 6000K

电压 | Voltage

DC24V

材质 | Material

铝材 | Aluminum product

颜色 | Body Color

黑色 | Black

防护等级 | Protection class

IP20

使用环境温度 | Ambient temperature

-20°C~40°C

2 型号 | Model

UNS-LC600F

尺寸 | size

L600*W15*H36mm

功率 | Power

18W

3 型号 | Model

UNS-LC900F

尺寸 | size

L900*W15*H36mm

功率 | Power

27W

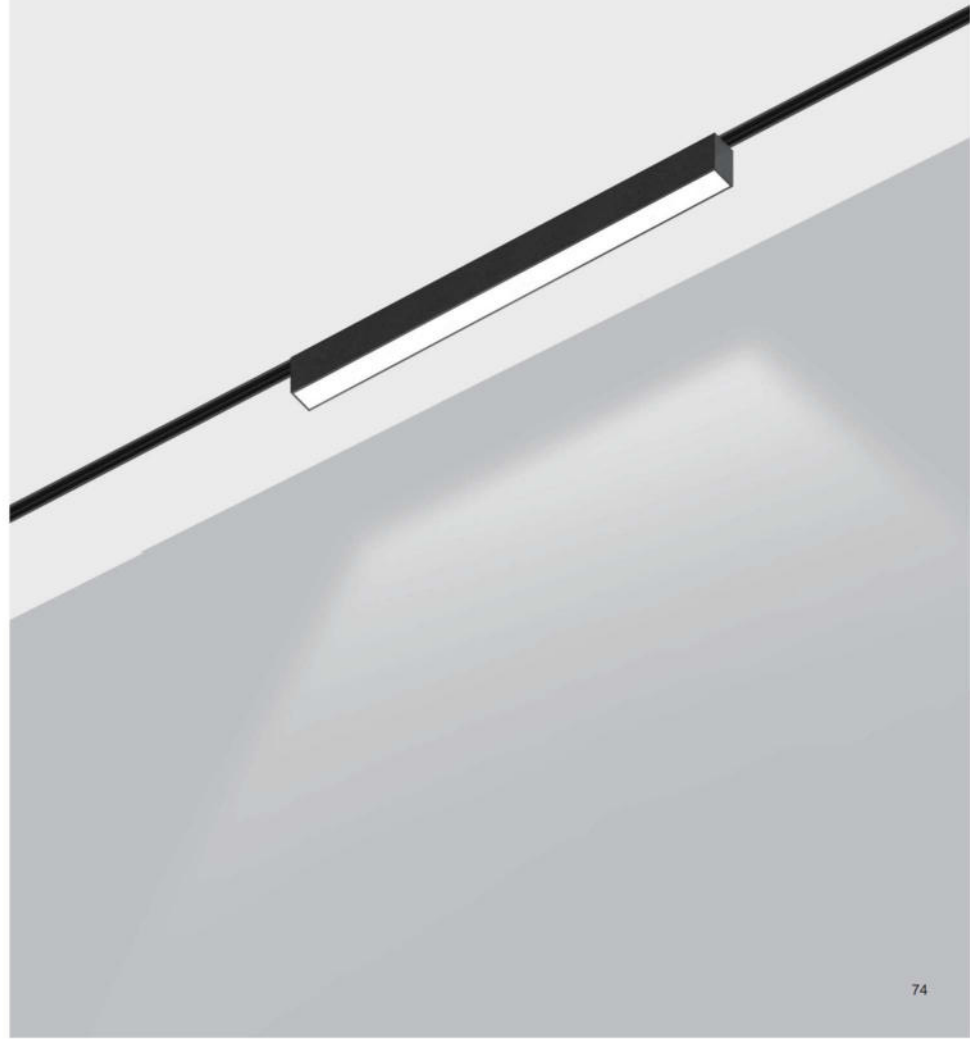



折叠格栅灯 | Folding light

① 型号 | Model

UNS-ZD-6T

尺寸 | size

L118*W15*H100mm

功率 | Power

6W

扩散罩 | Diffuser

lens

发光角度 | Luminous Angle

24°

色温 | Temperature

3000K / 4000K / 6000K

电压 | Voltage

DC24V

材质 | Material

铝材 | Aluminum product

颜色 | Body Color

黑色 | Black

防护等级 | Protection class

IP20

使用环境温度 | Ambient temperature

-20°C~40°C

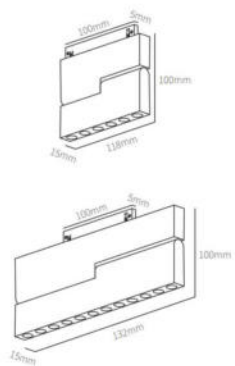

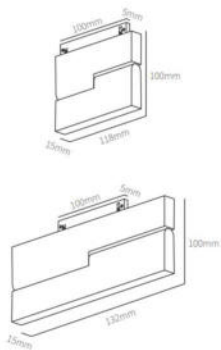

折叠泛光灯 | Floodlight Folding light

1 型号 | Model

UNS-ZD-6F

尺寸 | size

L118*W15*H100mm

功率 | Power

6W

扩散罩 | Diffuser

PC

发光角度 | Luminous Angle

120°

色温 | Temperature

3000K / 4000K / 6000K

电压 | Voltage

DC24V

材质 | Material

铝材 | Aluminum product

颜色 | Body Color

黑色 | Black

防护等级 | Protection class

IP20

使用环境温度 | Ambient temperature-

20°C-40°C

2 型号 | Model

UNS-ZD-12F

尺寸 | size

L232*W15*H100mm

功率 | Power

12W

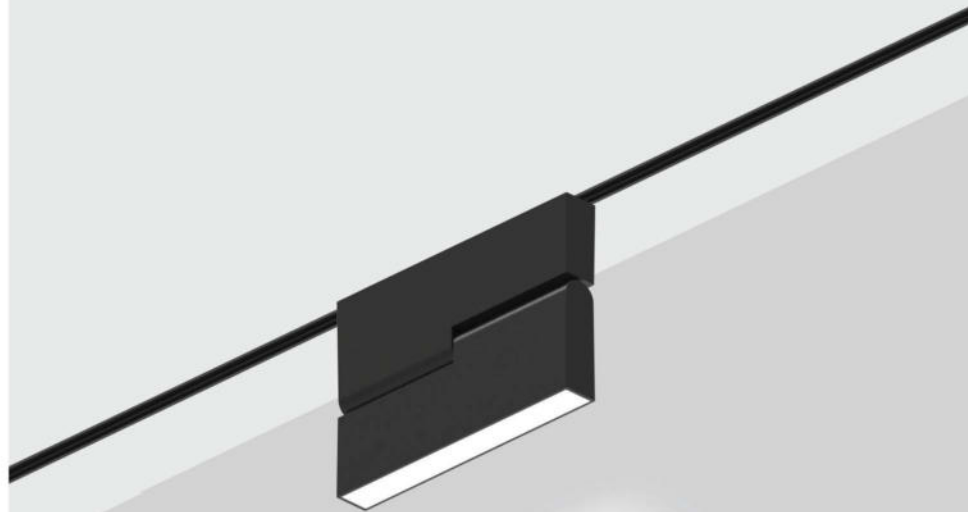

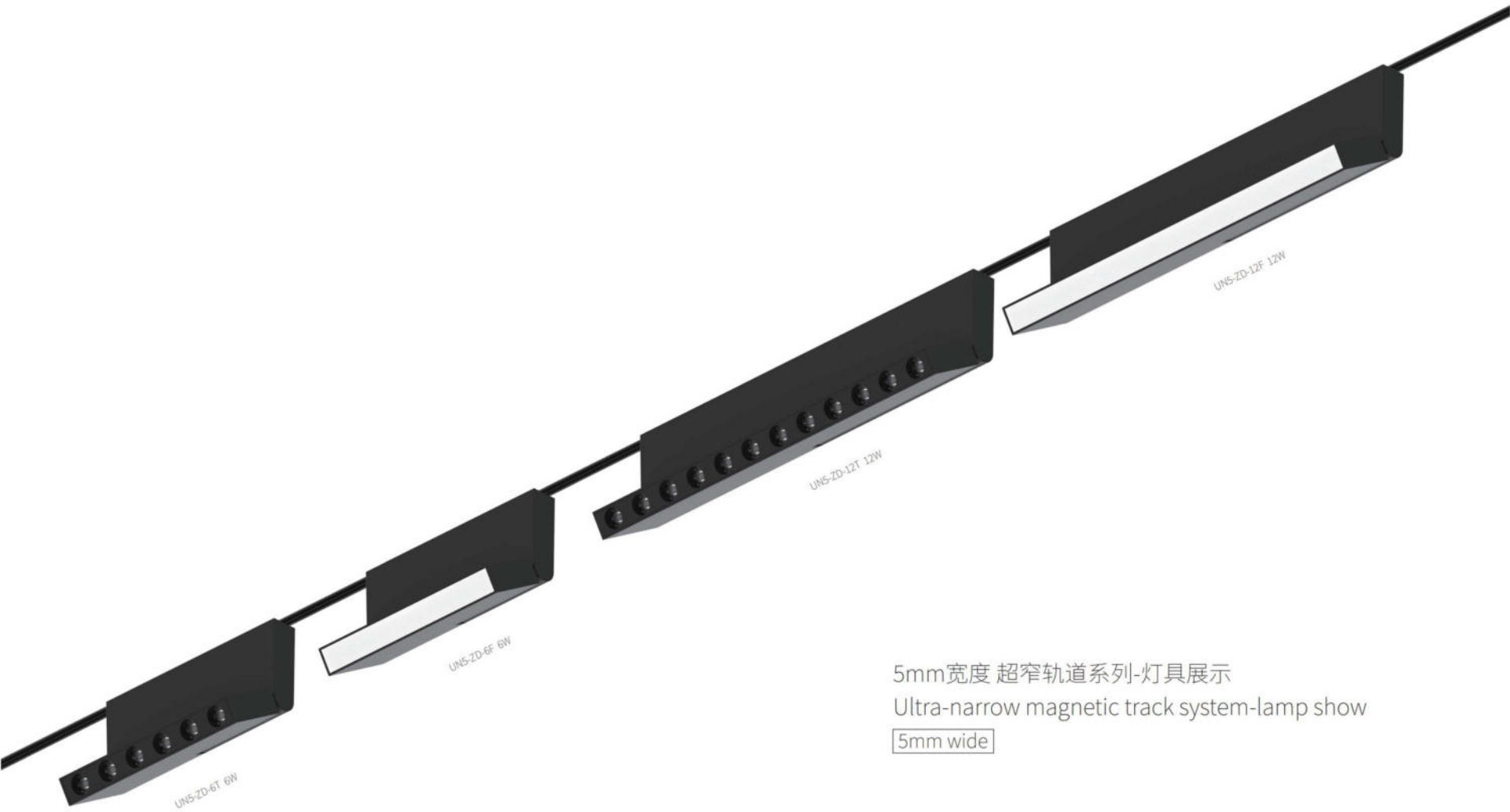

5mm宽度 超窄轨道系列-灯具展示
Ultra-narrow magnetic track system-lamp show

5mm wide



轨道射灯 | Track Lights

1 型号 | Model

UNS-L20

尺寸 | size

Ø20*L60mm

功率 | Power

3W

扩散罩 | Diffuser

lens

发光角度 | Luminous Angle

24°

色温 | Temperature

3000K / 4000K / 6000K

电压 | Voltage

DC24V

材质 | Material

铝材 | Aluminum product

颜色 | Body Color

黑色 | Black

防护等级 | Protection class

IP20

使用环境温度 | Ambient temperature

-20°C~40°C



垂直摆动90°
swing 90° vertically



水平摆动90°
swing 90° horizontal



5mm宽度 超窄轨道系列-灯具展示
Ultra-narrow magnetic track system-lamp show

5mm wide



轨道式阅读灯 | Track type reading light

型号 | Model
UNS-YDL20

尺寸 | size
Ø20*L60mm

功率 | Power
3W

扩散罩 | Diffuser
lens

发光角度 | Luminous Angle
24°

色温 | Temperature
3000K / 4000K / 6000K

电压 | Voltage
DC24V

材质 | Material
铝材 | Aluminum product

颜色 | Body Color
黑色 | Black

防护等级 | Protection class
IP20

使用环境温度 | Ambient temperature
-20°C~40°C

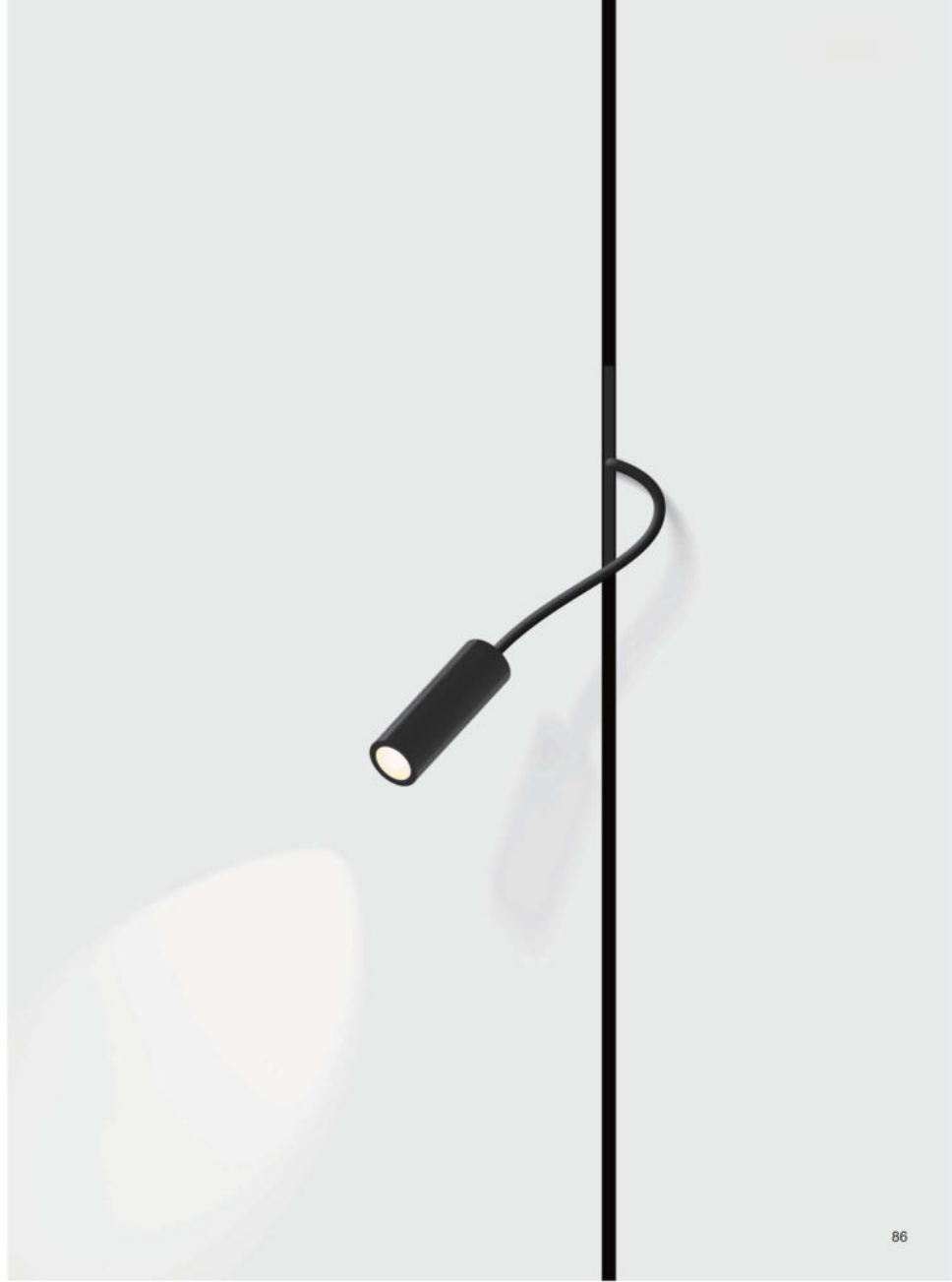



明装圆形射灯 | Surface mounted spotlights

型号 | Model
UNS-TD50

尺寸 | size
Ø50*H57mm

功率 | Power
6W

扩散罩 | Diffuser
lens

发光角度 | Luminous Angle
24°

色温 | Temperature
3000K / 4000K / 6000K

电压 | Voltage
DC24V

材质 | Material
铝材 | Aluminum product

颜色 | Body Color
黑色 | Black

防护等级 | Protection class
IP20

使用环境温度 | Ambient temperature
-20°C~40°C



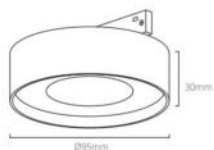

明装圆形射灯 | Surface mounted spotlights 9 in 1

型号 | Model
UNS-G90

尺寸 | size
Ø95*H30mm

功率 | Power
9W

扩散罩 | Diffuser
lens

发光角度 | Luminous Angle
24°

色温 | Temperature
3000K / 4000K / 6000K

电压 | Voltage
DC24V

材质 | Material
铝材 | Aluminum product

颜色 | Body Color
黑色 | Black

防护等级 | Protection class
IP20

使用环境温度 | Ambient temperature
-20°C~40°C



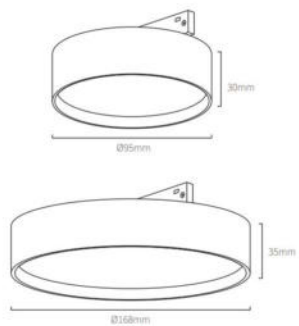

明装泛光灯 | Surface mounted - floodlight

① 型号 | Model

UNS-WB90

尺寸 | size

Ø95*H30mm

功率 | Power

9W

扩散罩 | Diffuser

PC

发光角度 | Luminous Angle

120°

色温 | Temperature

3000K / 4000K / 6000K

电压 | Voltage

DC24V

材质 | Material

铝材 | Aluminum product

颜色 | Body Color

黑色 | Black

防护等级 | Protection class

IP20

使用环境温度 | Ambient temperature

-20°C~40°C

② 型号 | Model

UNS-WB168

尺寸 | size

Ø168*H35

功率 | Power

18W



UNS-WB168 18W



UNS-WB90 9W

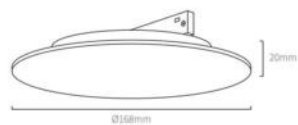

日蚀壁灯 | Solar eclipse Wall lamp

型号 | Model

UNS-YSBD

尺寸 | size

Ø168xH20mm

功率 | Power

9W

扩散罩 | Diffuser

PC

发光角度 | Luminous Angle

150°

色温 | Temperature

3000K / 4000K / 6000K

电压 | Voltage

DC24V

材质 | Material

铝材 | Aluminum product

颜色 | Body Color

黑色 | Black

防护等级 | Protection class

IP20

使用环境温度 | Ambient temperature

-20°C~40°C

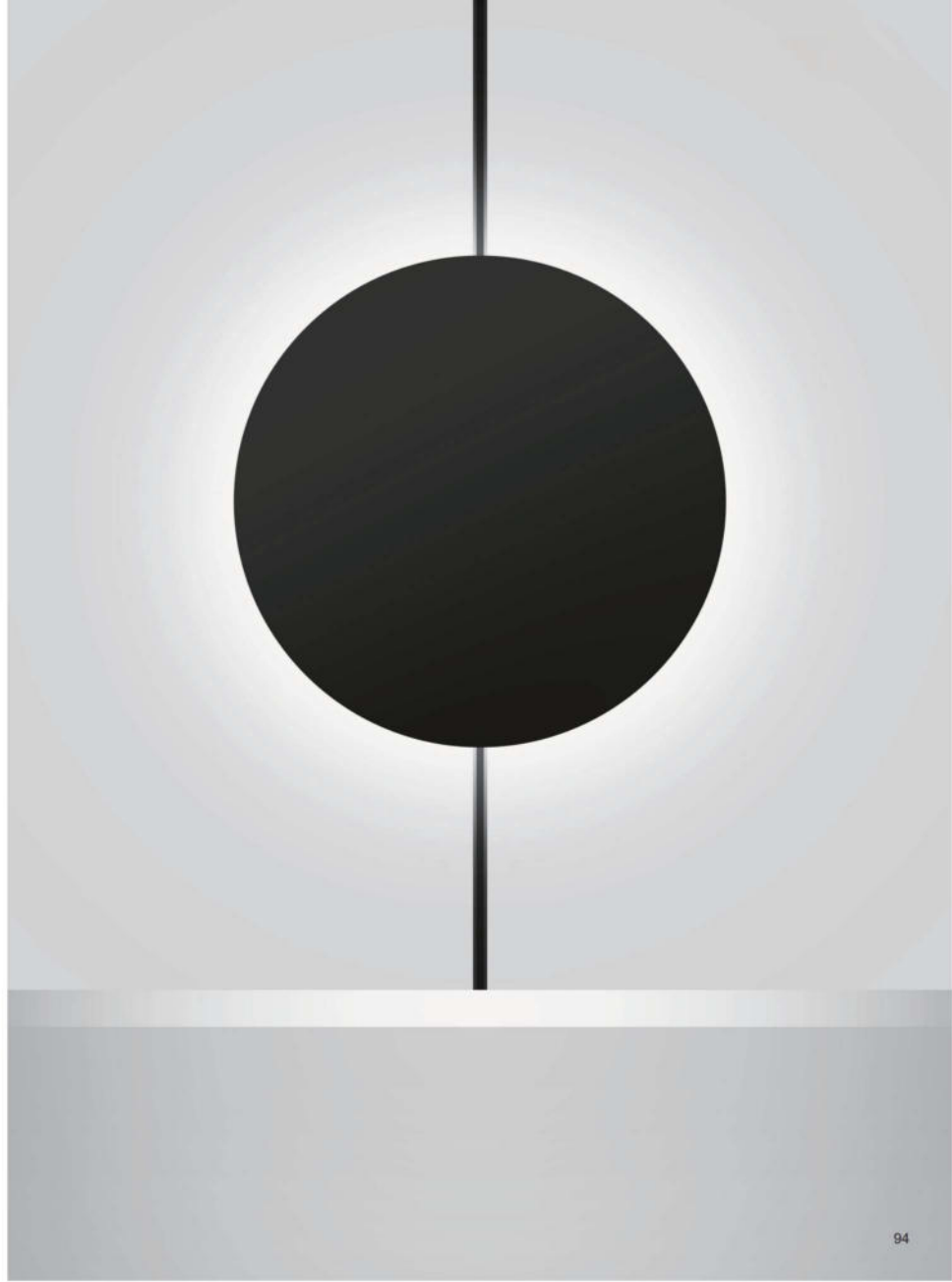

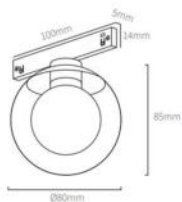

双层玻璃球装饰灯 | Frosted Glass Ball

型号 | Model
UN5-B80

尺寸 | size
Ø80*H85mm

功率 | Power
6W

扩散罩 | Diffuser
玻璃 | glass

发光角度 | Luminous Angle
150°

色温 | Temperature
3000K / 4000K / 6000K

电压 | Voltage
DC24V

材质 | Material
铝材 | Aluminum product

颜色 | Body Color
黑色 | Black

防护等级 | Protection class
IP20

使用环境温度 | Ambient temperature
-20°C~40°C



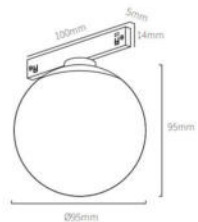

圆球灯 | track ball lamp

型号 | Model
UN5-P95

尺寸 | size
Ø95*H95mm

功率 | Power
6W

扩散罩 | Diffuser
PC

发光角度 | Luminous Angle
180°

色温 | Temperature
3000K / 4000K / 6000K

电压 | Voltage
DC24V

材质 | Material
铝材 | Aluminum product

颜色 | Body Color
黑色 | Black

防护等级 | Protection class
IP20

使用环境温度 | Ambient temperature
-20°C~40°C



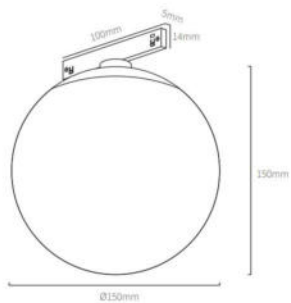

轨道式-地球(月球) | Track type -Earth(Moon)

- | | |
|--|---|
| <p>1 型号 Model
UNS-GDD150</p> <p>尺寸 size
Ø150*H150mm</p> <p>功率 Power
6W</p> <p>扩散罩 Diffuser
塑料 plastic</p> <p>发光角度 Luminous Angle
350°</p> <p>色温 Temperature
3000K / 4000K / 6000K</p> <p>电压 Voltage
DC24V</p> <p>材质 Material
铝材 Aluminum product</p> <p>颜色 Body Color
黑色 Black</p> <p>防护等级 Protection class
IP20</p> <p>使用环境温度 Ambient temperature
-20°C-40°C</p> | <p>2 型号 Model
UNS-GDY150</p> <p>尺寸 size
Ø150*H150mm</p> <p>功率 Power
6W</p> |
|--|---|

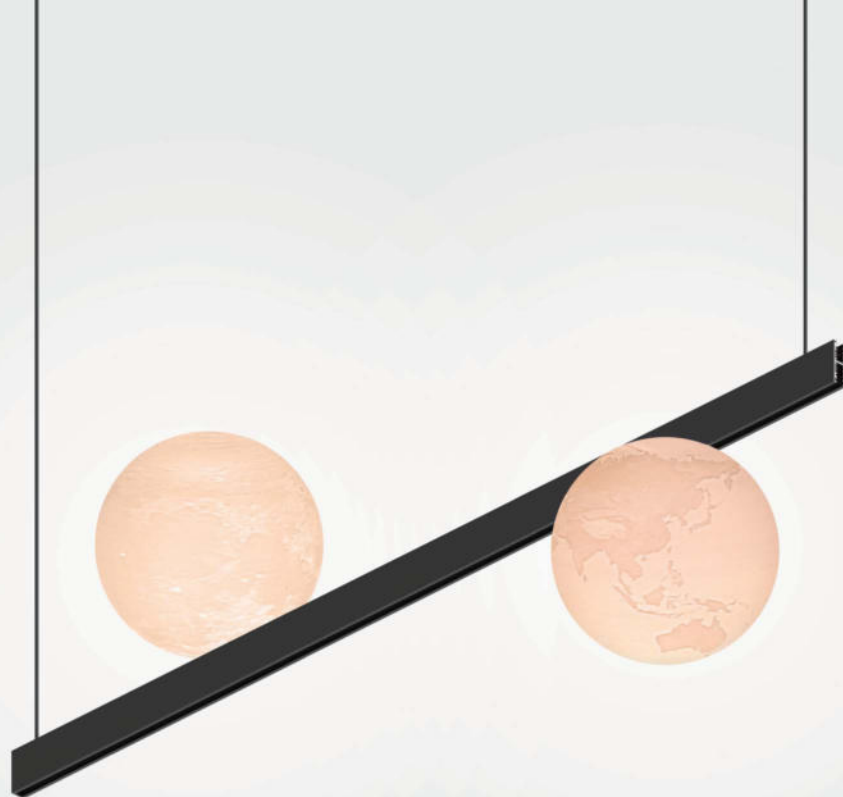

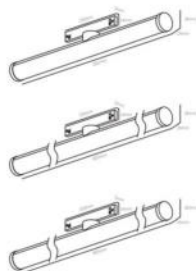

金刚棒-泛光灯 | Stick - floodlight

- | | | |
|---|---|---|
| <p>1 型号 Model
UNS-SS300F</p> <p>尺寸 size
L300xW25xH30mm</p> <p>功率 Power
9W</p> <p>扩散罩 Diffuser
PC</p> <p>发光角度 Luminous Angle
180°</p> <p>色温 Temperature
3000K / 4000K / 6000K</p> <p>电压 Voltage
DC24V</p> <p>材质 Material
铝材 Aluminum product</p> <p>颜色 Body Color
黑色 Black</p> <p>防护等级 Protection class
IP20</p> <p>使用环境温度 Ambient temperature
-20°C~40°C</p> | <p>2 型号 Model
UNS-SS600F</p> <p>尺寸 size
L600xW25xH30mm</p> <p>功率 Power
18W</p> | <p>3 型号 Model
UNS-SS900F</p> <p>尺寸 size
L900xW25xH30mm</p> <p>功率 Power
27W</p> |
|---|---|---|

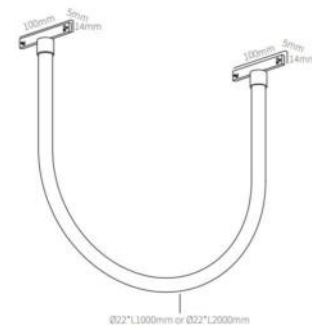

悬吊式软管-泛光 | Silicone light tube

- | | |
|--|--|
| <p>1 型号 Model
UNS-RG1000</p> <p>尺寸 size
Ø22*L1000mm</p> <p>功率 Power
14W</p> <p>扩散罩 Diffuser
硅胶管 Silicone tube</p> <p>发光角度 Luminous Angle
360°</p> <p>色温 Temperature
3000K / 4000K / 6000K</p> <p>电压 Voltage
DC24V</p> <p>材质 Material
铝材 Aluminum product</p> <p>颜色 Body Color
黑色 Black</p> <p>防护等级 Protection class
IP20</p> <p>使用环境温度 Ambient temperature
-20°C~40°C</p> | <p>2 型号 Model
UNS-RG2000</p> <p>尺寸 size
Ø22*L2000mm</p> <p>功率 Power
28W</p> |
|--|--|

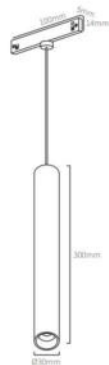

直式悬吊灯 | Hoisting-Straight cylinder

型号 | Model
UN5-30D300

尺寸 | size
Ø30*L300mm

功率 | Power
6W

扩散罩 | Diffuser
lens

发光角度 | Luminous Angle
24°

色温 | Temperature
3000K / 4000K / 6000K

电压 | Voltage
DC24V

材质 | Material
铝材 | Aluminum product

颜色 | Body Color
黑色 | Black

防护等级 | Protection class
IP20

使用环境温度 | Ambient temperature
-20°C~40°C





悬吊式圆球灯 | Suspended spherical lamp

型号 | Model

UN5-DP95

尺寸 | size

Ø95*H95mm

功率 | Power

6W

扩散罩 | Diffuser

PC

发光角度 | Luminous Angle

180°

色温 | Temperature

3000K / 4000K / 6000K

电压 | Voltage

DC24V

材质 | Material

铝材 | Aluminum product

颜色 | Body Color

黑色 | Black

防护等级 | Protection class

IP20

使用环境温度 | Ambient temperature

-20°C~40°C





星球悬吊灯-地球(月球) | Planet chandelier -Earth(Moon)

① 型号 | Model

UNS-D150

尺寸 | size

Ø150*H150mm

功率 | Power

6W

扩散罩 | Diffuser

塑料 | plastic

发光角度 | Luminous Angle

350°

色温 | Temperature

3000K / 4000K / 6000K

电压 | Voltage

DC24V

材质 | Material

铝材 | Aluminum product

颜色 | Body Color

黑色 | Black

防护等级 | Protection class

IP20

使用环境温度 | Ambient temperature

-20°C-40°C

② 型号 | Model

UNS-Y150

尺寸 | size

Ø150*H150mm

功率 | Power

6W





Colorful flexibility
Orbital system



炫彩系列2025

Colorful Series 2025



柔性轨道的优点体现在快速安装,可以在施工现场简单弯曲,以适应照明要求和建筑所要求的任何几何形状,可以勾勒出不同程度的曲线,自由而流畅的形状,与丰富的光性能结合在一起

The advantages of flexible tracks lie in their rapid installation and the ability to be simply bent at the construction site to fit According to the lighting requirements and any geometric shape required by the building, it can be outlined to varying degrees Curves, free and smooth shapes, combined with rich light performance.

多种颜色可供选择和自由搭配

A variety of colors are available for selection and free combination



黑色/Black



灰色/Gray



绿色/Green



卡其色/Khaki



橙色/Orange

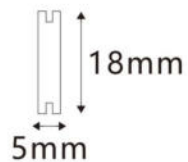

最小尺寸/Minimum dimensions

在一个最小截面中，两个铜导体与一段热塑性弹性体共挤出，但仍然完全安全地暴露在外。

一条纤细的谐波钢带沿着背面延伸，形成轮廓，并允许不同的几何形状被编织和保持。轨道变成一条可以在施工现场简单弯曲的带子，以适应由照明要求和建筑学决定的任何几何形状。

In a minimum cross-section, two copper conductors are co-extruded with a section of thermoplastic elastomer, but still completely and safely exposed.

A slender harmonic steel band extends along the back, forming an outline and allowing different geometries to be woven and maintained. The track becomes a band that can be simply bent at the construction site to adapt to any geometric shape determined by lighting requirements and architecture.

热塑性弹性体与铜导体正极和负极一起挤出

The thermoplastic elastomer is extruded together with the positive and negative poles of the copper conductor

可持续性

由于其材料特性, 轨道可以在原位切割和折叠, 最小半径为300毫米

Sustainability

Due to its material properties, the track can be cut and folded in situ with a minimum radius of 300 millimeters.

轨道交付/Track delivery

5-10-20米/卷 (mroll)



最小曲率半径/Minimum curvature radius

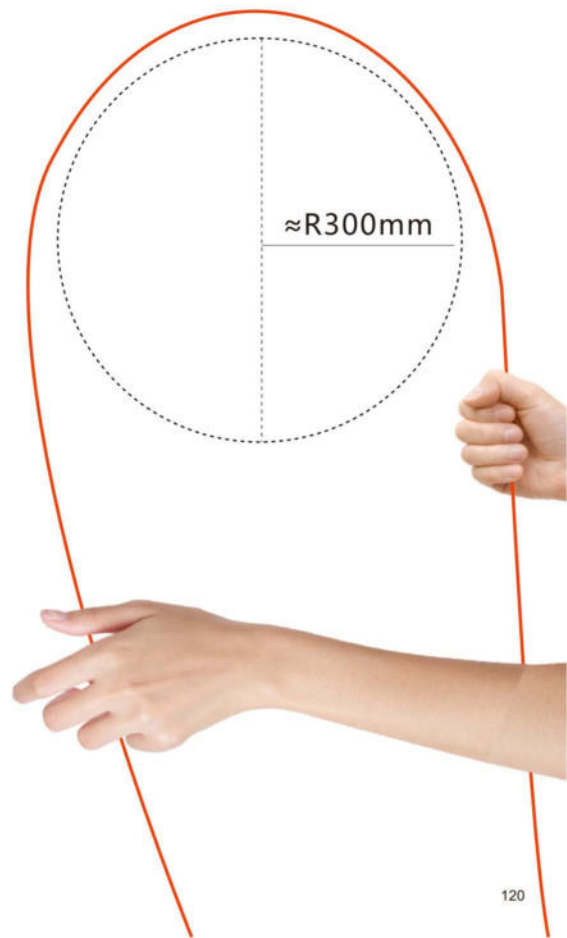

越来越多的配置, 从最小到最大的延伸, 墙壁和天花板布局的一些案例

More and more configurations, from the smallest to the largest extensions, some cases of wall and ceiling layouts

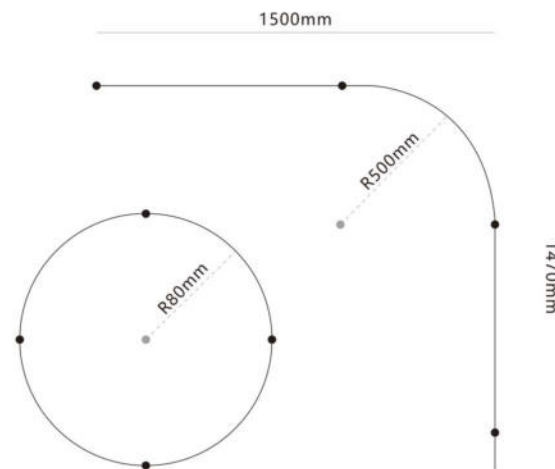
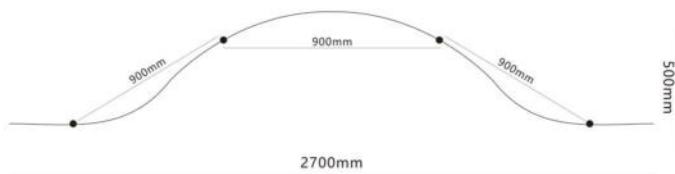
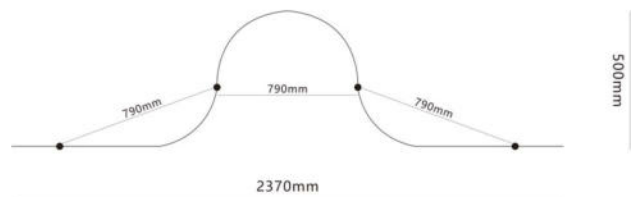



半柔轨道是一种多功能的创意性照明系统，它将轨道的概念提升到了一个新的高度。

通过不同的DIY，突出产品的艺术性，装饰性。
以导电轨道带为核心，灯具可以自由摆放，并能
在现场创造出独特的照明解决方案

The semi-flexible track is a multi-functional and creative lighting system that elevates the concept of the track Reach a new height.

Through various DIY activities, highlight the artistry and decorative nature of the products.

With the conductive track band as the core, the lamps can be freely placed and can Create unique lighting solutions on the spot



超薄柔性线性轨道-结合使用

根据您的需要选择您喜欢的安装方式

Ultra-thin flexible linear track - used in combination
Choose the installation method you like according to your needs



柔性轨道配件 Flexible track accessories



暗装吊饰五金件 型号/Model: BR1801 Concealed installation of pendant hardware

产品尺寸: $\Phi 60 \times H 50 \text{mm}$

Product Size: $\Phi 60 \times H 50 \text{mm}$

功能/Function

1. 天花板外置电源暗装藏线盖。
 2. 适用于天花板, 墙壁安装。
1. Concealed wire cover for external power supply on the ceiling.
 2. Suitable for ceiling and wall installation.

安装步骤/Installation steps

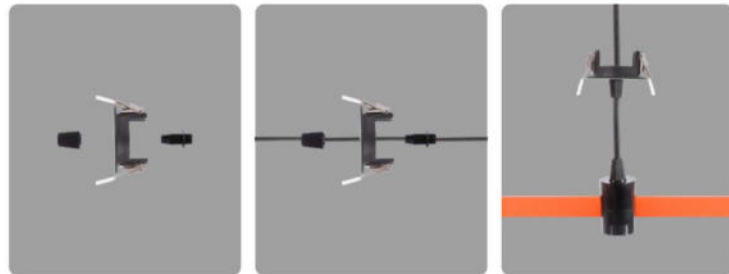

柔性轨道配件 Braided track accessories



明装吊饰五金件 型号/Model: BR1802 Exposed pendant hardware

产品尺寸: $\Phi 50 \times H 47 \text{mm}$

Product Size: $\Phi 60 \times H 50 \text{mm}$

功能/Function

1. 天花板明装藏线盖。
 2. 适用于天花板, 墙壁安装。
1. Ceiling exposed concealed wire cover.
 2. Suitable for ceiling and wall installation.

安装步骤/Installation steps

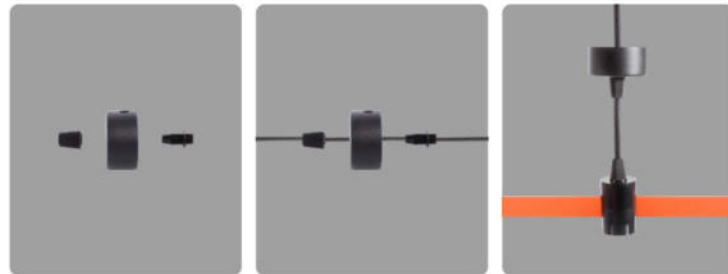

柔性轨道配件 Braided track accessories



输入模块 型号/Model: BR1803 Input module

产品尺寸: $\Phi 32 \times H 47.5 \text{mm}$

Product Size: $\Phi 32 \times H 47.5 \text{mm}$

功能/Function

1. 轨道导电转换功能。
 2. 轨道供电作用。
 3. 搭配吊饰五金件安装
1. Orbital conductive conversion function.
 2. Rail power supply function.
 3. Installation of accessories and hardware.

安装步骤/Installation steps

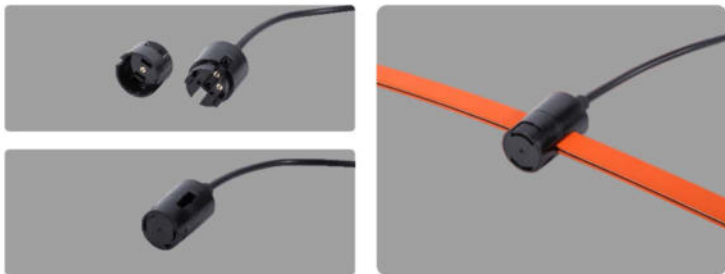

柔性轨道配件 Braided track accessories

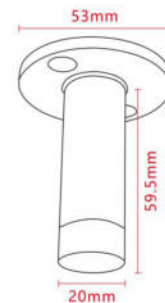

塑料固定 型号/Model: BR1804 Plastic fixation

产品尺寸: $59.5 \times 20 \times 53 \text{mm}$

Product Size: $59.5 \times 20 \times 53 \text{mm}$

功能/Function

1. 半柔塑料五金轨道固定头。
1. Semi-flexible plastic hardware track fixing head.

安装步骤/Installation steps



柔性轨道配件 Braided track accessories

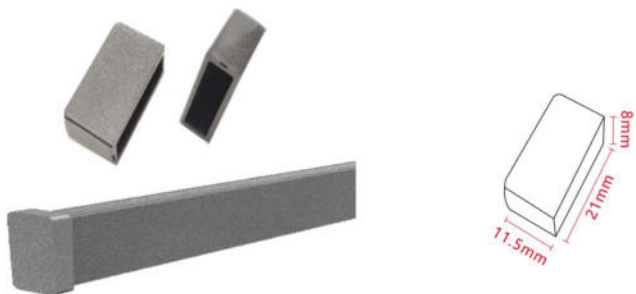

轨道堵头 型号/Model: BR1806 Track plug

产品尺寸: 21×8×11.5mm

Product Size: 21×8×11.5mm

功能/Function

1. 轨道堵头盖子。
2. 美饰作用。
1. Track plug cover.
2. Aesthetic function.

安装步骤/Installation steps

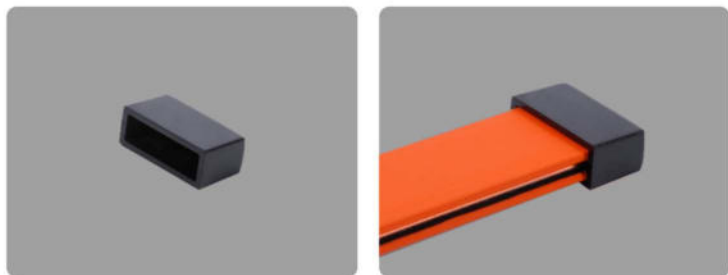

柔性轨道配件 Braided track accessories



转接模块 型号/Model: BR1807 Adapter module

产品尺寸: 62×26×12mm

Product Size: 62×26×12mm

功能/Function

1. 半柔轨道的五金连接件。
2. 改变轨道方向
1. Hardware connectors for semi-flexible tracks.
2. Change the direction of the orbit.

安装步骤/Installation steps

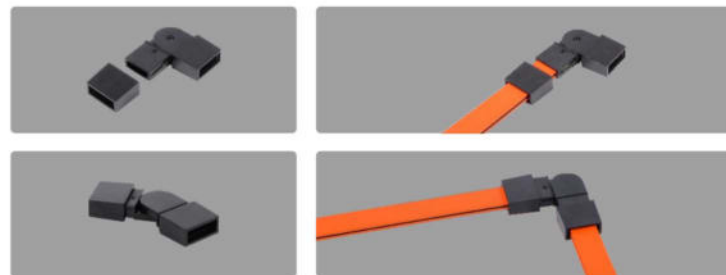



通过轨道不断地衔接创造出需要的造型, 这是很好的创意, 非常实用。

适用于商业空间

It is a great idea to continuously connect the tracks to create the required shapes, which is very practical.

Applicable to commercial Spaces



可通过轨道拼接出理想的造型, 用在每个空间

The ideal shape can be formed by splicing the tracks and used in every space



适用于休闲空间、商业空间、家庭氛围

It is suitable for leisure Spaces, commercial
Spaces and home atmospheres





超薄线性轨道-结合使用

根据您的需要选择您喜欢的安装方式

Ultra-thin linear track - used in combination
Choose the installation method you like according to your needs

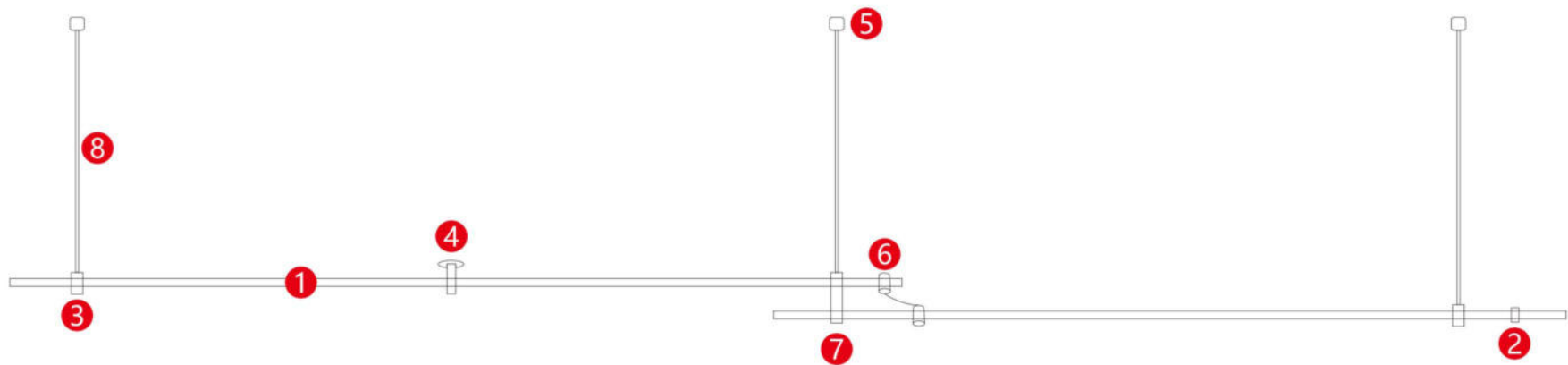

1



轨道
Orbit

2



轨道堵头
Track plug

3



输入模块
Input module

4



一体化电源
Integrated power supply

5



塑料固定
Plastic fixation

6



双头输入导电模块
Dual-head input
conductive module

7



五金双层旋转吊杆
Double-layer rotating
hanging wire rod for hardware

8



五金加长杆
Hardware extension rod

线性轨道配件 Linear track accessories



五金加长杆 型号/Model: WJ1801 Hardware extension rod

产品尺寸: 300/600/900mm(可定制长度)
Product Size: 300/600/900mm(The length can be customized.)

功能/Function

1. 天花板与轨道的五金加长杆 1. The hardware extension rods for the ceiling and the track.

安装步骤/Installation steps

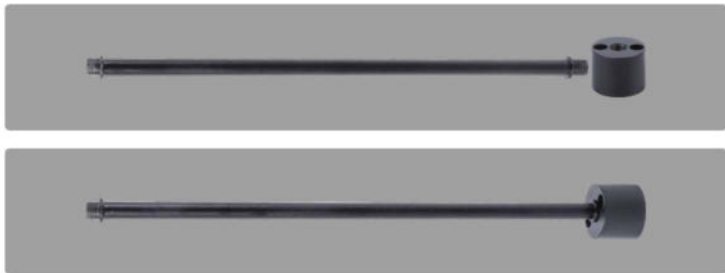

线性轨道配件 Linear track accessories

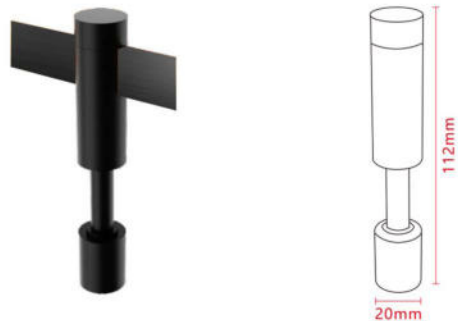

塑料固定 型号/Model: BR1805 Plastic fixation

产品尺寸: $\Phi 20 \times H112\text{mm}$ Product Size: $\Phi 20 \times H112\text{mm}$

功能/Function

1. 固定轨道。 1. Fixed track.

安装步骤/Installation steps



线性轨道配件 Linear track accessories



五金双层旋转吊线杆 型号/Model: WJ1804 Double-layer rotating hanging wire rod for hardware

产品尺寸: $\Phi 20 \times H160\text{mm}$

Product Size: $\Phi 20 \times H160\text{mm}$

功能/Function

1. 轨道与轨道拼接上下连接杆(可350°旋转)。
1. Track and track splicing upper and lower connecting rods (can be rotated 350°).

安装步骤/Installation steps



线性轨道配件 Linear track accessories



双头输入导电模块 型号/Model: WJ1805 Dual-head input conductive module

产品尺寸: 350mm

Product Size: 350mm

功能/Function

1. 轨道与轨道拼接上下导电连接头。
1. Track and track splicing upper and lower conductive connection heads.
2. 轨道供电作用。
2. Rail power supply function.
3. 搭配电源器使用。
3. Use in conjunction with a power supply.

安装步骤/Installation steps





用圆圈创造出不同的造型, 给到空间很好的装饰

Create different shapes with circles to provide a good decoration for the space



不同颜色的圆圈装饰到家庭里面有不一样的感觉

Circles of different colors, when decorated in a home, give a distinct feeling

LOUNGE

POWER ROOM
CONTROL ROOM

圆圈碰上圆圈, 是一个不错的创意
Circles meeting circles is a good idea





超薄圆圈线性轨道-结合使用

根据您的需要选择您喜欢的安装方式

Ultra-thin circular linear track - used in combination
Choose the installation method you like according to your needs



1
轨道
Orbit



2
圆形导电吊线配件
Circular conductive
hanging wire accessories



3
圆形五金吊线配件
Circular hardware
hanging wire accessories

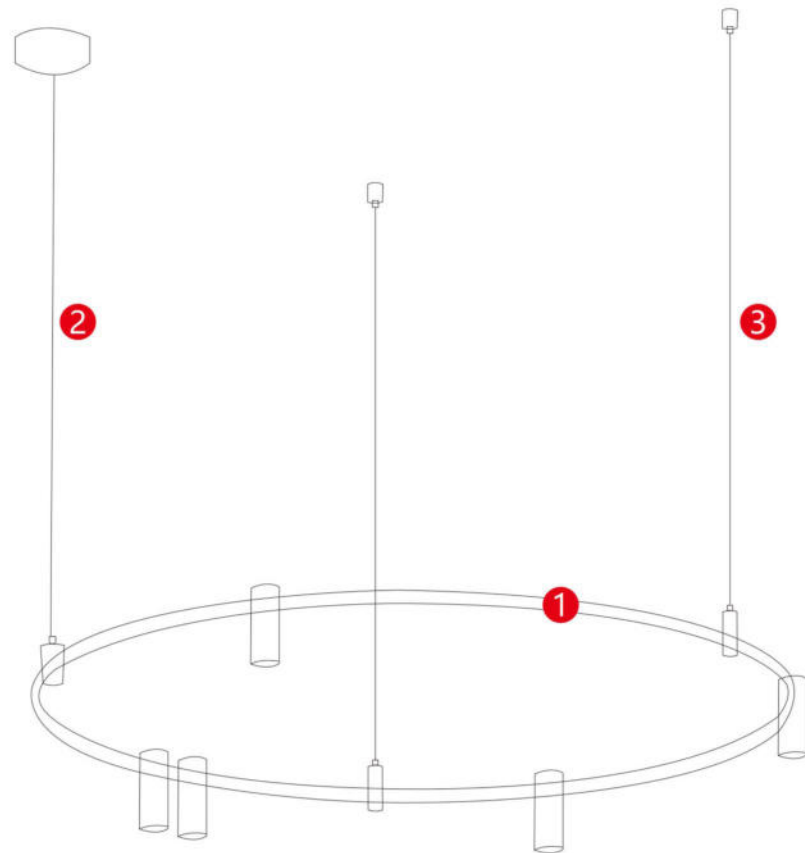

■ 圆圈铝材轨道 Circular aluminum track

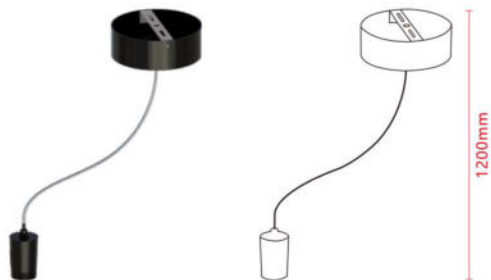

圆形导电吊线配件 型号/Model: YQ1801 Circular conductive hanging wire accessories

产品尺寸: 1200mm吊线

Product Size: 1200mm Hanging line

功能/Function

1. 圆圈导电吊线吸顶盘。
 2. 轨道供电作用。
 3. 搭配电源器使用。
1. Circular conductive hanging wire ceiling panel.
 2. Rail power supply function.
 3. Use in conjunction with a power supply.

安装步骤/Installation steps



■ 圆圈铝材轨道 Circular aluminum track

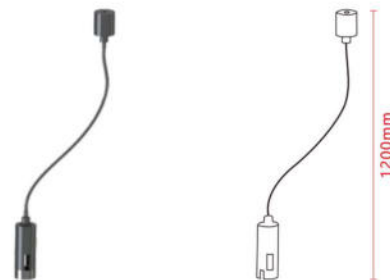

圆形五金吊线配件 型号/Model: YQ1802 Circular hardware hanging wire accessories

产品尺寸: 1200mm吊线

Product Size: 1200mm Hanging line

功能/Function

1. 圆圈吊线。
1. Circular hanging line.

安装步骤/Installation steps



电源产品规格书 Power supply product specification sheet

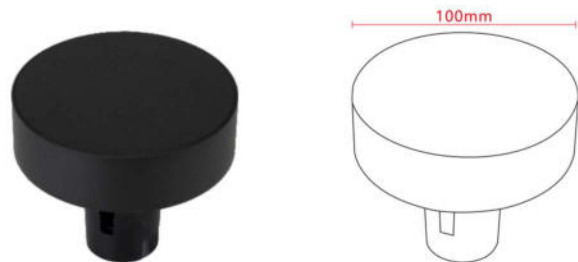

半柔一体电源

Semi-flexible integrated power supply

100/200W

光源型号 Light source model /	功率 Power 100W/200W	尺寸 Size 100mm
扩散罩 Diffuser PC	发光角度 Luminous Angle /	色温 Color temperature /
电压 Diffuser 48V	材质 Luminous Angle 导电头(PC) 铝(Aluminum)	颜色 Colour 黑色/Black
防护等级 Protection grade IP20	使用环境温度 Operating ambient temperature -20°C~40°C	

安装步骤/Installation steps

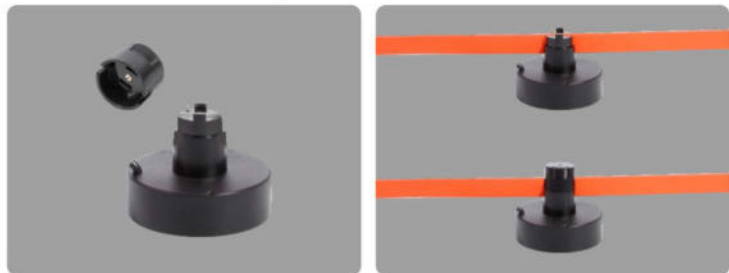

电源产品规格书 Power supply product specification sheet

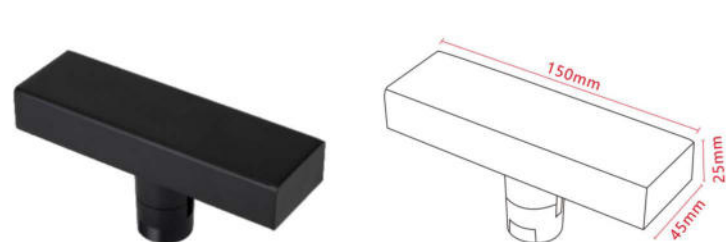

半柔智能一体电源

Semi-flexible intelligent integrated power supply

光源型号 Light source model /	功率 Power 100W/200W	尺寸 Size 45*25*150mm
扩散罩 Diffuser PC	发光角度 Luminous Angle /	色温 Color temperature /
电压 Diffuser 48V	材质 Luminous Angle 导电头(PC) 铝(Aluminum)	颜色 Colour 黑色/Black
防护等级 Protection grade IP20	使用环境温度 Operating ambient temperature -20°C~40°C	

安装步骤/Installation steps



■ 灯具产品规格书 Specification sheet of Lighting products

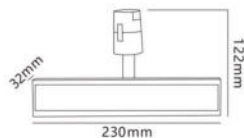

半柔泛光灯 型号/Model: FG1803 Semi-soft floodlight

功率 | Power
10W

发光角度 | Luminous Angle
120°

尺寸 | Size
230*32*122mm



灯体可旋转
The lamp body can rotate



轨道外壳/轨道条颜色可自由更换
The color of the track shell/track strip can be freely changed



电压: DC48V
Voltage: DC48V



直径: ≥90
Dia: ≥90



颜色: 黑/白/金
Colour: Black/White/Gold



材质: 铝+PC
Material: Aluminum+PC

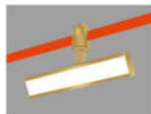

无频闪: < 3%
No Flicker: < 3%



光学: PC模块
Optics: PC module

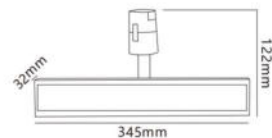

半柔泛光灯 型号/Model: FG1804 Semi-soft floodlight

功率 | Power
18W

发光角度 | Luminous Angle
120°

尺寸 | Size
345*32*122mm



安装方式
Installation method

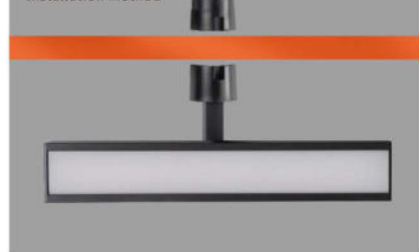

■ 灯具产品规格书 Specification sheet of Lighting products

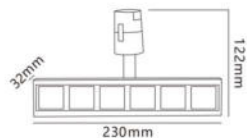

半柔格栅灯 型号/Model: GS1801 Folding grille lamp

功率 | Power
10W

发光角度 | Luminous Angle
24°

尺寸 | Size
230*32*122mm

ON-OFF CCT 3000-6000K

灯体可旋转
The lamp body can rotate



轨道外壳/轨道条颜色可自由更换
The color of the track shell/track strip can be freely changed



电压: DC48V
Voltage: DC48V



显指: ≥90
CRI: ≥90



颜色: 黑/白/金
Colour: Black/White/Gold



材质: 铝+PC
Material: Aluminum+PC

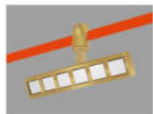

无频闪: < 3%
No Flicker: < 3%



光学: 透镜
Optics: Lens

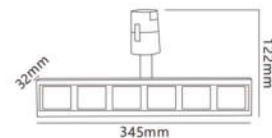

半柔格栅灯 型号/Model: GS1802 Folding grille lamp

功率 | Power
15W

发光角度 | Luminous Angle
24°

尺寸 | Size
345*32*122mm

ON-OFF CCT 3000-6000K

安装方式
Installation method



■ 灯具产品规格书 Specification sheet of Lighting products

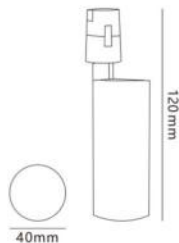

半柔射灯 型号/Model: GD1805 Semi-soft spotlights

功率 | Power
9W

发光角度 | Luminous Angle
24°

尺寸 | Size
40*120mm



灯体可旋转
The lamp body can rotate



轨道外壳/轨道条颜色可自由更换
The color of the track shell/track strip can be freely changed



电压: DC48V
Voltage: DC48V

显指: ≥90
CRI: ≥90



颜色: 黑/白/金
Colour: Black/White/Gold

材质: 铝+PC
Material: Aluminum+PC

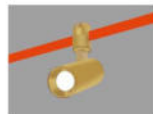

无频闪: < 3%
No Flicker: < 3%

光学: 透镜
Optics: Lens

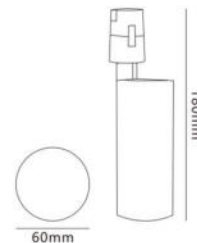

半柔射灯 型号/Model: GD1806 Semi-soft spotlights

功率 | Power
15W

发光角度 | Luminous Angle
24°

尺寸 | Size
60*180mm



安装方式
Installation method



灯具产品规格书 Specification sheet of Lighting products

灯体可旋转
The lamp body can rotate

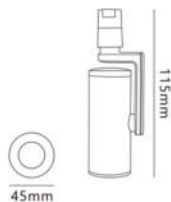

射灯B 型号/Model: GD1807 Spotlight B

功率 | Power 10W 发光角度 | Luminous Angle 24° 尺寸 | Size 45*115mm

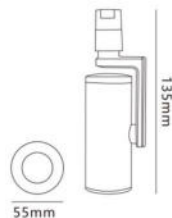

射灯B 型号/Model: GD1808 Spotlight B

功率 | Power 20W 发光角度 | Luminous Angle 24° 尺寸 | Size 55*135mm

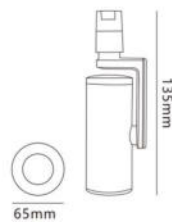

射灯B 型号/Model: GD1809 Spotlight B

功率 | Power 30W 发光角度 | Luminous Angle 24° 尺寸 | Size 65*135mm



轨道外壳/轨道条颜色可自由更换
The color of the track shell/track strip can be freely changed



电压: DC48V
Voltage: DC48V
显指: ≥90
CRI: ≥90



颜色: 黑/白/金
Colour: Black/White/Gold
材质: 铝+PC
Material: Aluminum+PC



无频闪: < 3%
No Flicker: < 3%
光学: 透镜
Optics: Lens

■ 灯具产品规格书 Specification sheet of Lighting products

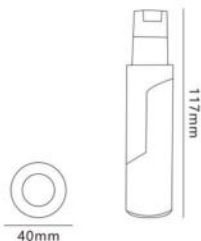

折叠射灯 型号/Model: GD1810 Spotlight B

功率 | Power
7W

发光角度 | Luminous Angle
24°

尺寸 | Size
40*117mm

ON-OFF

CCT 3000-6000K

灯体可旋转
The lamp body can rotate



轨道外壳/轨道条颜色可自由更换
The color of the track shell/track strip can be freely changed



电压: DC48V
Voltage: DC48V



颜色: 黑/白/金
Colour: Black/White/Gold



无频闪: < 3%
No Flicker: < 3%

显指: ≥90
CRI: ≥90

材质: 铝+PC
Material: Aluminum+PC

光学: 透镜
Optics: Lens

安装方式
Installation method



■ 灯具产品规格书 Specification sheet of Lighting products



调焦折叠射灯 型号/Model: GD1811 Focus folding spotlights

功率 | Power
10W

发光角度 | Luminous Angle
15°-55°

尺寸 | Size
45*120mm

ON-OFF CCT 3000-6000K

灯体可旋转

The lamp body can rotate



轨道外壳/轨道条颜色可自由更换
The color of the track shell/track strip can be freely changed



电压: DC48V
Voltage: DC48V



显指: ≥90
CRI: ≥90



颜色: 黑/白/金
Colour: Black/White/Gold

材质: 铝+PC
Material: Aluminum+PC



无频闪: < 3%
No Flicker: < 3%



光学: 透镜
Optics: Lens

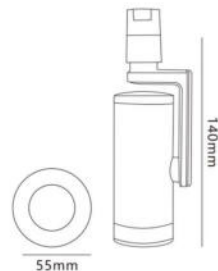

调焦折叠射灯 型号/Model: GD1812 Focus folding spotlights

功率 | Power
20W

发光角度 | Luminous Angle
15°-55°

尺寸 | Size
55*140mm

ON-OFF CCT 3000-6000K

安装方式
Installation method



灯具产品规格书 Specification sheet of Lighting products

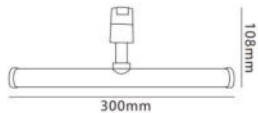

半柔D25泛光灯 型号/Model: DG1813 Semi-flexible D25 floodlight

功率 | Power
10W

发光角度 | Luminous Angle
280°

尺寸 | Size
300*108mm



灯体可旋转

The lamp body can rotate



轨道外壳/轨道条颜色可自由更换
The color of the track shell/track strip can be freely changed

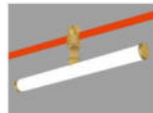

电压: DC48V
Voltage: DC48V



频闪: $\leq 3\%$
CB $\leq 3\%$



颜色: 黑/白/金
Colour: Black/White/Gold



材质: 铝+PC
Material: Aluminum+PC



无频闪: <math>< 3\%</math>
No Flicker: <math>< 3\%</math>



光学: PC模块
Optics: PC module

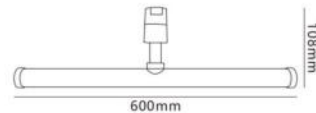

半柔D25泛光灯 型号/Model: DG1814 Semi-flexible D25 floodlight

功率 | Power
20W

发光角度 | Luminous Angle
280°

尺寸 | Size
600*108mm



安装方式
Installation method



■ 灯具产品规格书 Specification sheet of Lighting products

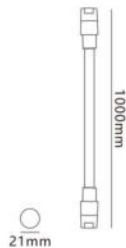

半柔硅胶灯带 型号/Model: DG1824 Semi-flexible silicone light strips

功率 | Power
10W

发光角度 | Luminous Angle
360°

尺寸 | Size
1000*21mm

ON-OFF CCT 3000-6000K

灯体可旋转

The lamp body can rotate



轨道外壳/轨道条颜色可自由更换
The color of the track shell/track strip can be freely changed



电压: DC48V
Voltage: DC48V

显指: ≥90
CRI: ≥90



颜色: 黑/白/金
Colour: Black/White/Gold

材质: 铝+PC
Material: Aluminum+PC



无频闪: < 3%
No Flicker: < 3%

光学: PC模块
Optics: PC module



半柔硅胶灯带 型号/Model: DG1825 Semi-flexible silicone light strips

功率 | Power
20W

发光角度 | Luminous Angle
360°

尺寸 | Size
2000*21mm

ON-OFF CCT 3000-6000K

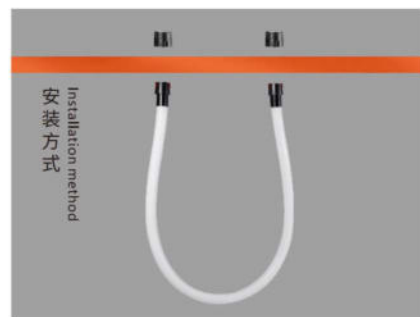

■ 灯具产品规格书 Specification sheet of Lighting products

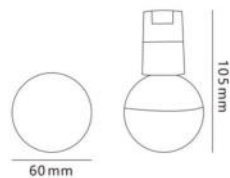

半柔小圆球 型号/Model: YQ1815 Semi-soft small ball

功率 | Power
7W

发光角度 | Luminous Angle
180°

尺寸 | Size
105*60mm



轨道外壳/轨道条颜色可自由更换
The color of the track shell/track strip can be freely changed

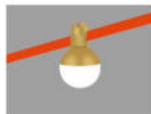

电压: DC48V
Voltage: DC48V



显指: ≥90
CRI: ≥90



颜色: 黑/白/金
Colour: Black/White/Gold



材质: 铝+PC
Material: Aluminum+PC



无频闪: < 3%
No Flicker: < 3%



光学: PC模块
Optics: PC module

安装方式
Installation method



■ 灯具产品规格书 Specification sheet of Lighting products

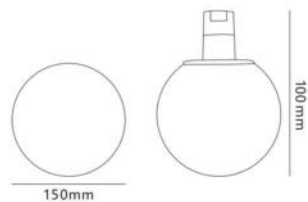

半柔球泡灯 型号/Model: YQ1816 Semi-flexible bulb lamp

功率 | Power
7W

发光角度 | Luminous Angle
180°

尺寸 | Size
150*100 mm

ON-OFF

CCT | 3000-6000K

轨道外壳/轨道条颜色可自由更换 The color of the track shell/track strip can be freely changed



电压: DC48V
Voltage: DC48V

显指: ≥90
CRI: ≥90



颜色: 黑/白/金
Colour: Black/White/Gold

材质: 铝+PC
Material: Aluminum+PC

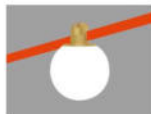

无频闪: < 3%
No Flicker: < 3%

光学: PC模块
Optics: PC module

安装方式 Installation method



■ 灯具产品规格书 Specification sheet of Lighting products

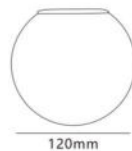

圆球吊线灯 型号/Model: DX1832 Spherical hanging line lamp

功率 | Power
7W

发光角度 | Luminous Angle
105°

尺寸 | Size
120mm

ON-OFF CCT 3000-6000K

轨道外壳/轨道条颜色可自由更换
The color of the track shell/track strip can be freely changed



电压: DC48V
Voltage: DC48V
显指: ≥90
CRI ≥90



颜色: 黑/白/金
Colour: Black/White/Gold
材质: 铝+PC
Material: Aluminum+PC

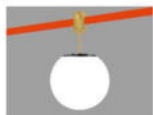

无频闪: < 3%
No Flicker: < 3%
光学: PC模块
Optics: PC module



■ 灯具产品规格书 Specification sheet of Lighting products

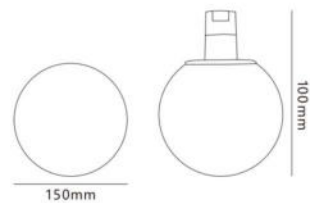

球中球 型号/Model: YQ1820

A ball within a ball

功率 | Power
5W

发光角度 | Luminous Angle
180°

尺寸 | Size
150*100mm

ON-OFF CCT 3000-6000K

轨道外壳/轨道条颜色可自由更换
The color of the track shell/track strip can be freely changed



电压: DC48V
Voltage: DC48V

显指: ≥90
CRI: ≥90



颜色: 黑/白/金
Colour: Black/White/Gold

材质: 铝+PC
Material: Aluminum+PC

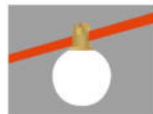

无频闪: < 3%
No Flicker: < 3%

光学: PC模块
Optics: PC module

安装方式
Installation method



■ 灯具产品规格书 Specification sheet of Lighting products

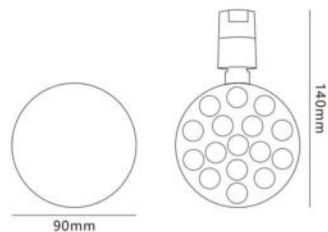

半柔圆盘格栅灯 型号/Model: YS1818 Semi-flexible disc grille lamp

功率 | Power
10W

发光角度 | Luminous Angle
24°

尺寸 | Size
140*90mm

ON-OFF

CCT | 3000-6000K

灯体可旋转

The lamp body can rotate



轨道外壳/轨道条颜色可自由更换
The color of the track shell/track strip can be freely changed



电压: DC48V
Voltage: DC48V



显指: ≥90
CRI: ≥90



颜色: 黑/白/金
Colour: Black/White/Gold



材质: 铝+PC
Material: Aluminum+PC



无频闪: < 3%
No Flicker: < 3%



光学: 透镜
Optics: Lens

安装方式

Installation method



■ 灯具产品规格书 Specification sheet of Lighting products

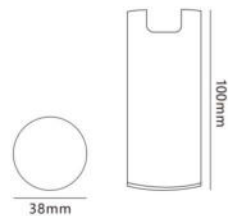

半柔筒射灯 型号/Model: MZ1817 Semi-flexible tube spotlights

功率 | Power
7W

发光角度 | Luminous Angle
24°

尺寸 | Size
38*100mm



轨道外壳/轨道条颜色可自由更换 The color of the track shell/track strip can be freely changed



电压: DC48V
Voltage: DC48V



显指: ≥90
CRI: ≥90



颜色: 黑/白/金
Colour: Black/White/Gold



材质: 铝+PC
Material: Aluminum+PC



无频闪: < 3%
No Flicker: < 3%



光学: 透镜
Optics: Lens

安装方式 Installation method



■ 灯具产品规格书 Specification sheet of Lighting products

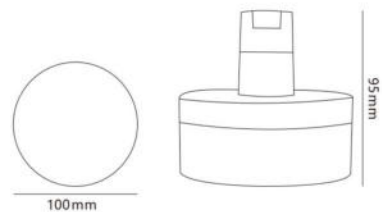

半柔亚克力泛光灯 型号/Model: YQ1821 Semi-flexible acrylic floodlight

功率 | Power 6W 发光角度 | Luminous Angle 120° 尺寸 | Size 100*95mm

ON-OFF CCT 3000-6000K

轨道外壳/轨道条颜色可自由更换
The color of the track shell/track strip can be freely changed

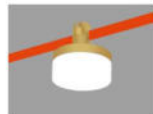

电压: DC48V
Voltage: DC48V



显指: ≥90
CRI: ≥90



颜色: 黑/白/金
Colour: Black/White/Gold



材质: 铝+PC
Material: Aluminum+PC



无频闪: < 3%
No Flicker: < 3%



光学: PC模块
Optics: PC module

安装方式
Installation method



■ 灯具产品规格书 Specification sheet of Lighting products

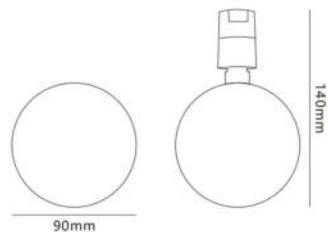

半柔圆形盘泛光灯 型号 / Model: YF1819 Semi-flexible circular disc floodlight

功率 | Power
10W

发光角度 | Luminous Angle
105°

尺寸 | Size
140*90mm



灯体可旋转
The lamp body can rotate



轨道外壳/轨道条颜色可自由更换
The color of the track shell/track strip can be freely changed



电压: DC48V
Voltage: DC48V

显指: ≥90
CRI: ≥90

颜色: 黑/白/金
Colour: Black/White/Gold

材质: 铝+PC
Material: Aluminum+PC

无频闪: < 3%
No Flicker: < 3%

光学: PC模块
Optics: PC module

安装方式
Installation method



■ 灯具产品规格书 Specification sheet of Lighting products

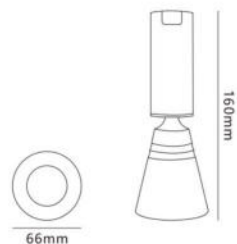

半柔圆锥款射灯 型号/Model: YJ1828 Semi-flexible conical spotlights

功率 | Power
7W

发光角度 | Luminous Angle
24°

尺寸 | Size
160*66mm



灯体可旋转
The lamp body can rotate



轨道外壳/轨道条颜色可自由更换
The color of the track shell/track strip can be freely changed



电压: DC48V
Voltage: DC48V

颜色: 黑/白/金
Colour: Black/White/Gold

无频闪: < 3%
No Flicker: < 3%

显指: ≥90
CRI: ≥90

材质: 铝+PC
Material: Aluminum+PC

光学: 透镜
Optics: Lens

安装方式
Installation method



■ 灯具产品规格书 Specification sheet of Lighting products

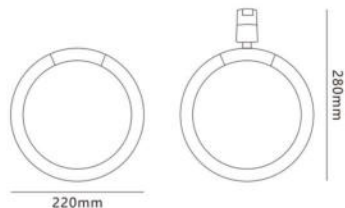

圆环灯 型号/Model: YH1823 Circular lamp

功率 | Power
8W

发光角度 | Luminous Angle
360°

尺寸 | Size
220*280mm



灯体可旋转
The lamp body can rotate



轨道外壳/轨道条颜色可自由更换
The color of the track shell/track strip can be freely changed



电压: DC48V
Voltage: DC48V



显指: ≥90
CRI: ≥90



颜色: 黑/白/金
Colour: Black/White/Gold

材质: 铝+PC
Material: Aluminum+PC



无频闪: < 3%
No Flicker: < 3%

光学: PC模块
Optics: PC module

安装方式
Installation method



■ 灯具产品规格书 Specification sheet of Lighting products

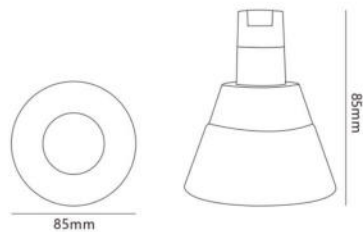

亚克力吊线灯 型号/Model: DX1830 Acrylic hanging line lamp

功率 | Power
7W

发光角度 | Luminous Angle
105°

尺寸 | Size
85*85mm



轨道外壳/轨道条颜色可自由更换
The color of the track shell/track strip can be freely changed



电压: DC48V
Voltage: DC48V



显指: ≥90
CRI: ≥90



颜色: 黑/白/金
Colour: Black/White/Gold



材质: 铝+PC
Material: Aluminum+PC



无频闪: < 3%
No Flicker: < 3%



光学: 透镜
Optics: Lens

安装方式
Installation method



■ 灯具产品规格书 Specification sheet of Lighting products

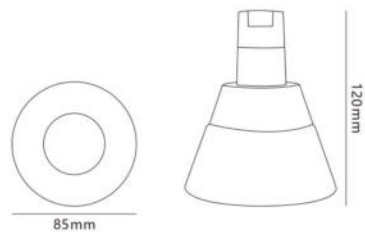

半柔圆锥款亚克力射灯 型号/Model: BL1829 Semi-flexible conical acrylic spotlights

功率 | Power 6W 发光角度 | Luminous Angle 105° 尺寸 | Size 85*120mm

ON-OFF CCT | 3000-6000K

轨道外壳/轨道条颜色可自由更换
The color of the track shell/track strip can be freely changed



电压: DC48V
Voltage: DC48V



显指: ≥90
CRI: ≥90



颜色: 黑/白/金
Colour: Black/White/Gold



材质: 铝+PC
Material: Aluminum+PC



无频闪: < 3%
No Flicker: < 3%



光学: 透镜
Optics: Lens

安装方式
Installation method



■ 灯具产品规格书 Specification sheet of Lighting products

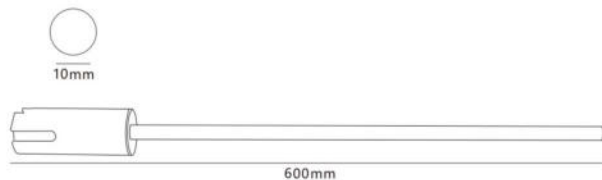

半柔D12长管灯 型号/Model: XS1822 Semi-flexible D12 long tube lamp

功率 | Power
2W

发光角度 | Luminous Angle
18°

尺寸 | Size
10*600mm



灯体可旋转
The lamp body can rotate



轨道外壳/轨道条颜色可自由更换
The color of the track shell/track strip can be freely changed



电压: DC48V
Voltage: DC48V

显指: ≥90
CRI: ≥90



颜色: 黑/白/金
Colour: Black/White/Gold

材质: 铝+PC
Material: Aluminum+PC



无频闪: < 3%
No Flicker: < 3%

光学: 透镜
Optics: Lens



安装方式
Installation method

■ 灯具产品规格书 Specification sheet of Lighting products



万向吊线灯 型号/Model: DX1833 Universal hanging wire lamp

功率 | Power
10W

发光角度 | Luminous Angle
24°

尺寸 | Size
65*80mm



轨道外壳/轨道条颜色可自由更换 The color of the track shell/track strip can be freely changed



电压: DC48V
Voltage: DC48V



显指: ≥90
CRI: ≥90



颜色: 黑/白/金
Colour: Black/White/Gold



材质: 铝+PC
Material: Aluminum+PC



无频闪: < 3%
No Flicker: < 3%



光学: 透镜
Optics: Lens

安装方式 Installation method



■ 灯具产品规格书 Specification sheet of Lighting products

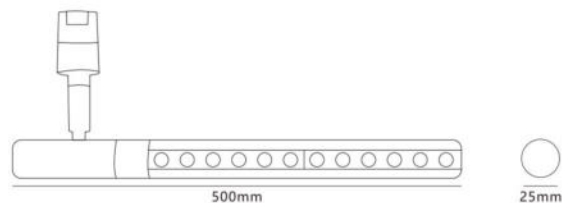

拼接旋转射灯 型号/Model: PJ1827 Spliced rotating spotlights

功率 | Power
15W

发光角度 | Luminous Angle
24°

尺寸 | Size
25*500mm

ON-OFF CCT 3000-6000K

灯体可旋转
The lamp body can rotate



轨道外壳/轨道条颜色可自由更换
The color of the track shell/track strip can be freely changed

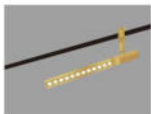
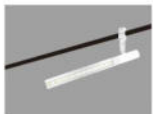

电压: DC48V
Voltage: DC48V



显指: ≥90
CRI: ≥90



颜色: 黑/白/金
Colour: Black/White/Gold



材质: 铝+PC
Material: Aluminum+PC



无频闪: < 3%
No Flicker: < 3%



光学: PC模块
Optics: PC module

安装方式
Installation method



■ 灯具产品规格书 Specification sheet of Lighting products



拼接旋转泛光灯 型号/Model: PJ1826 Spliced rotating floodlights

功率 | Power 15W 发光角度 | Luminous Angle 105° 尺寸 | Size 25*500mm

ON-OFF CCT 3000-6000K

灯体可旋转
The lamp body can rotate



轨道外壳/轨道条颜色可自由更换
The color of the track shell/track strip can be freely changed

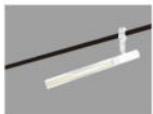

电压: DC48V
Voltage: DC48V



显指: ≥90
CRI: ≥90



颜色: 黑/白/金
Colour: Black/White/Gold



材质: 铝+PC
Material: Aluminum+PC



无频闪: < 3%
No Flicker: < 3%



光学: PC模块
Optics: PC module

安装方式
Installation method



